

CARMELO

1

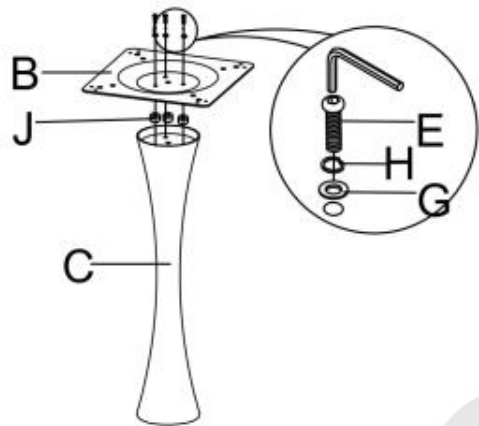

2

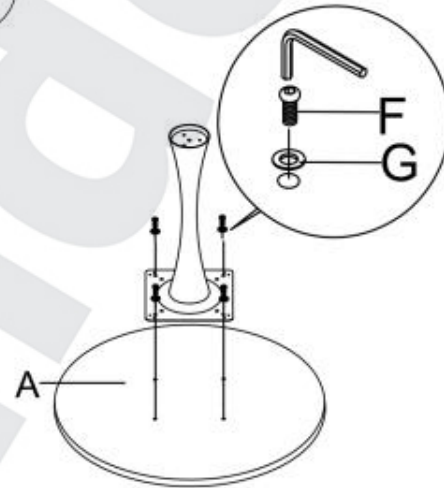



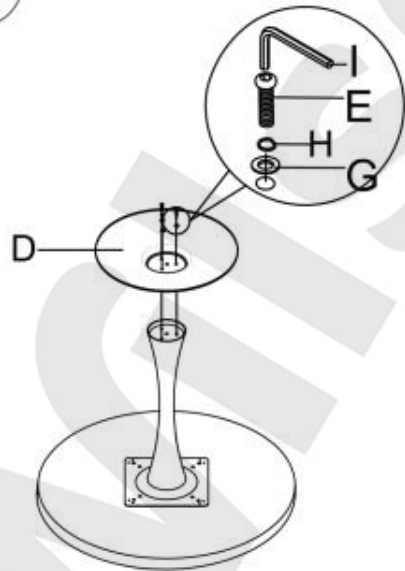





3



 MAX.30kg



A		1
B		1
C		1
D		1
E	 M8x40	6
F	 M8x20	4
G	 M6	10
H	 M6	6
I		3