





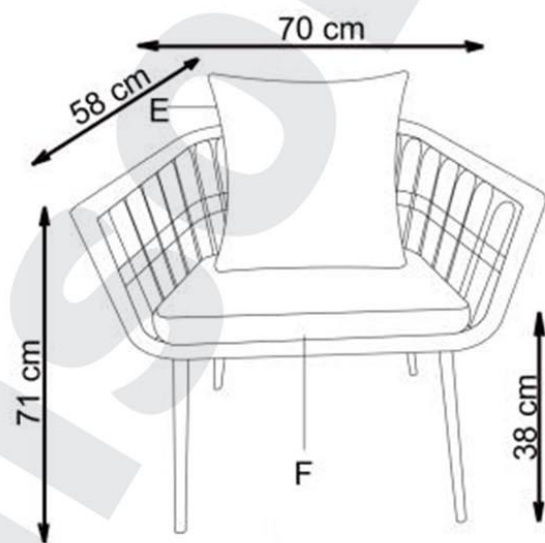

A		1
B		2
C		2
D		12
E		1
F		1



 max. 100 kg