

MILANO S1

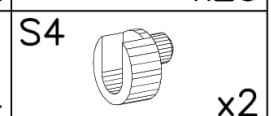

1

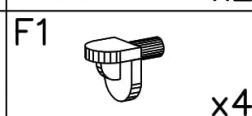
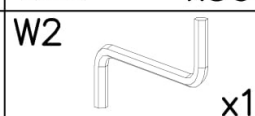
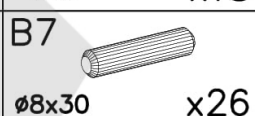
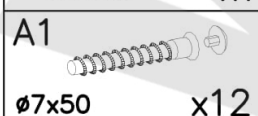
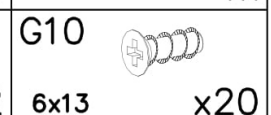
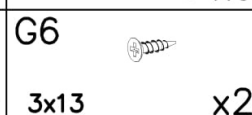
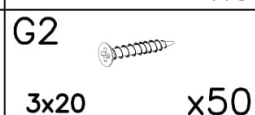
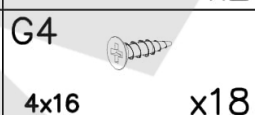
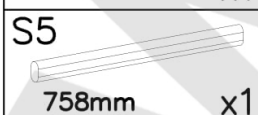
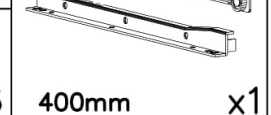
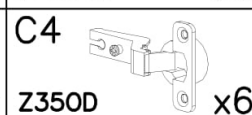
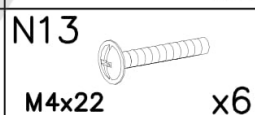
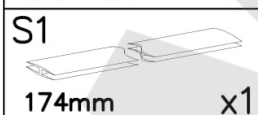
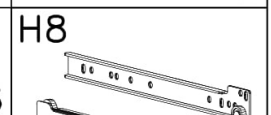
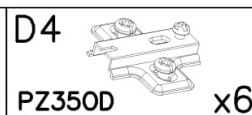
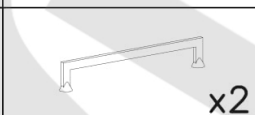
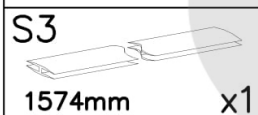
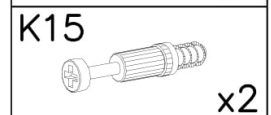
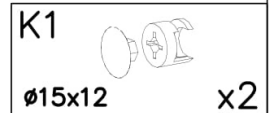
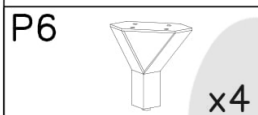
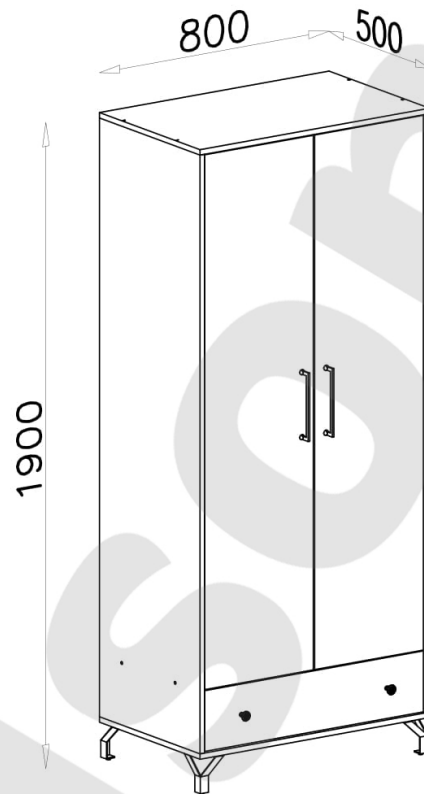
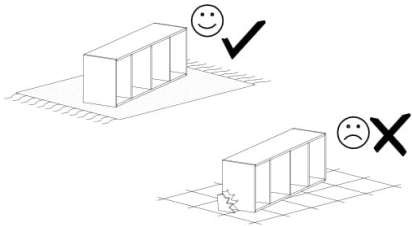
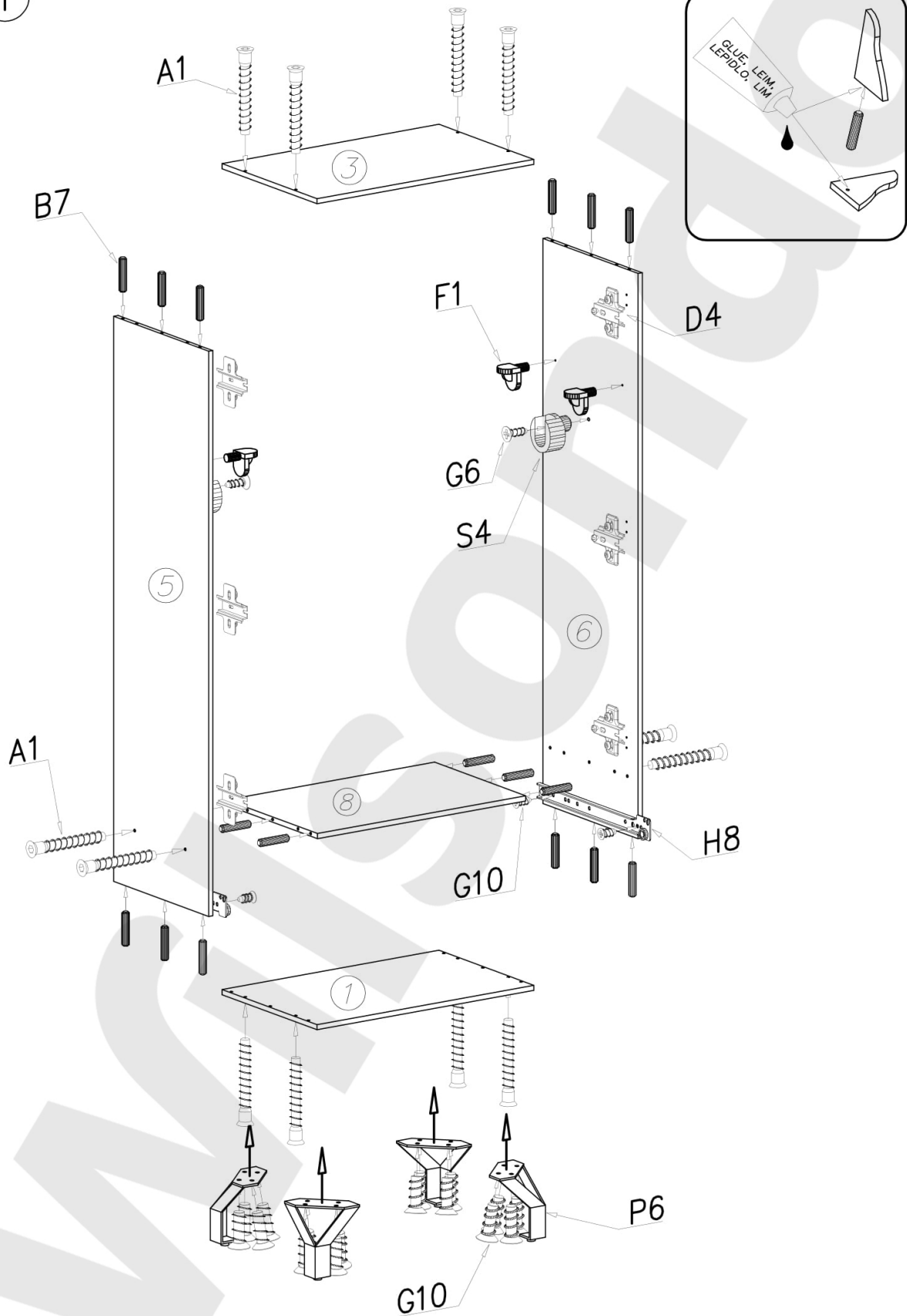

II

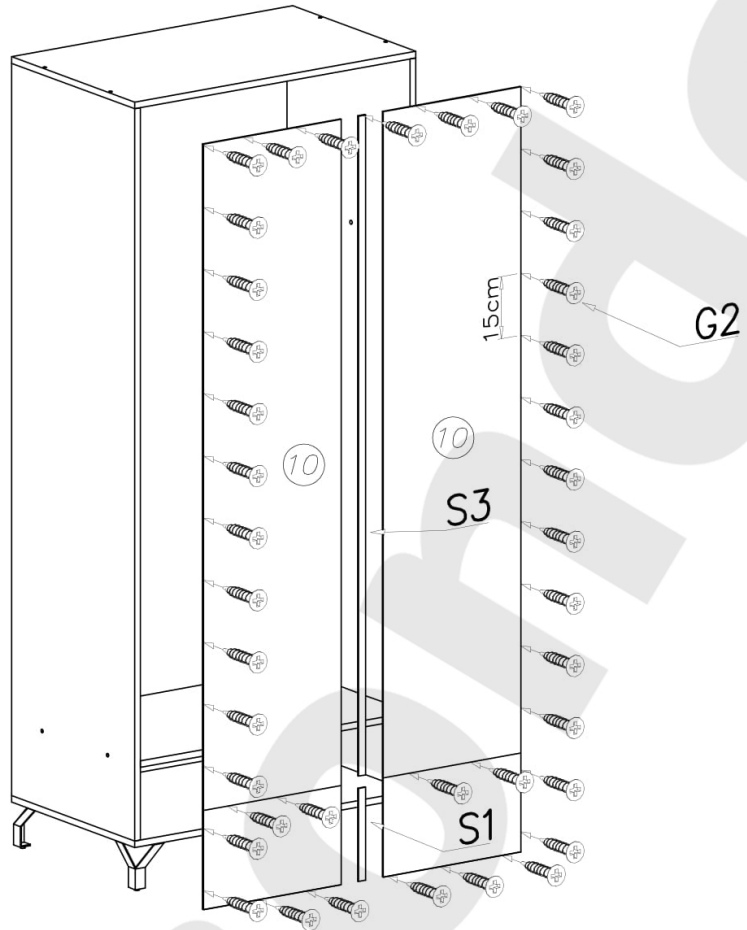

III

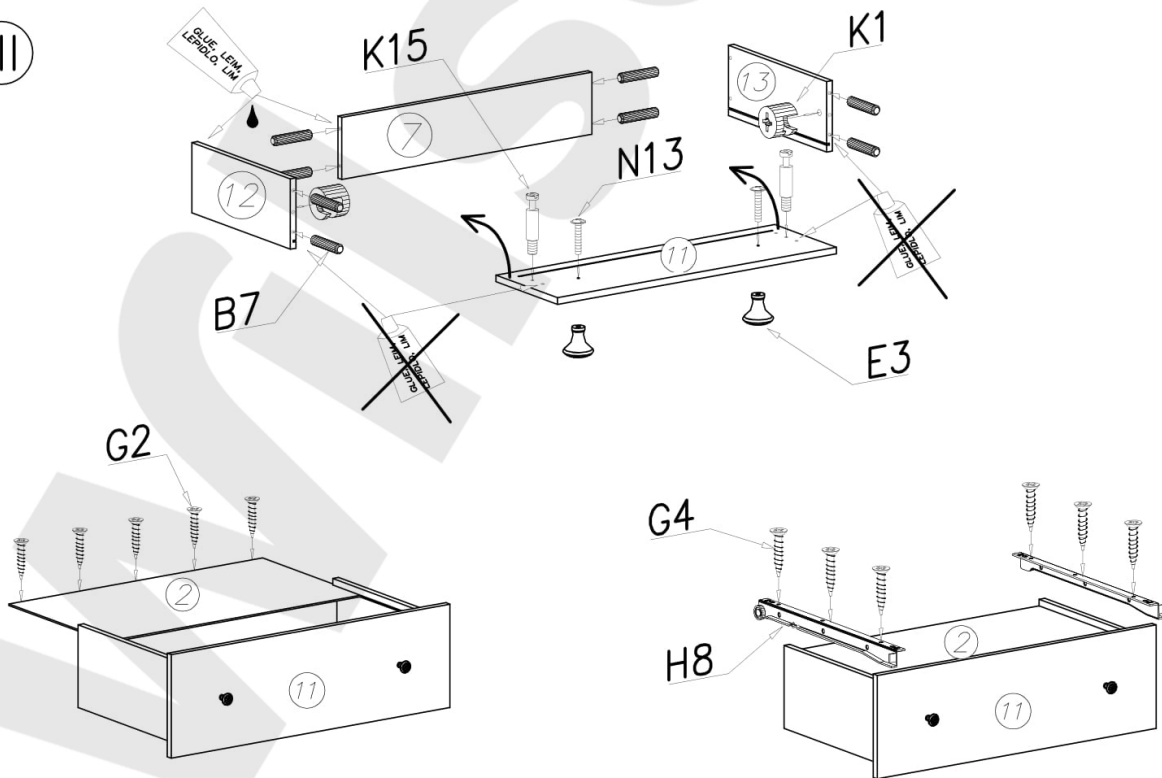

IV

