

# MONA – 3

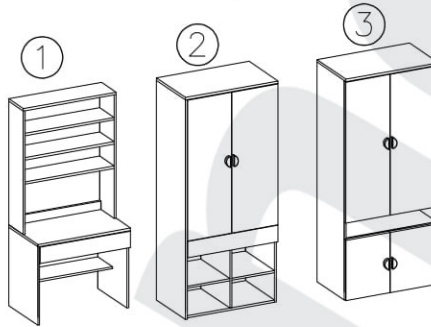

#	X	ks / db
1	411	1
2	412	2
3	413	2
4	120	1
5	121	1
6	210	1
7	510	2
8	511	2
9	610	2
10	611	2
11	010	2

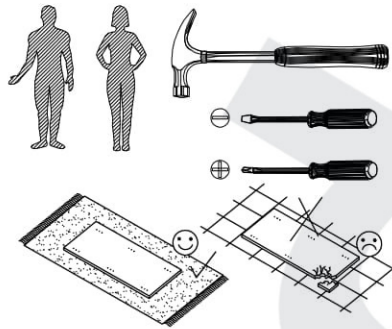
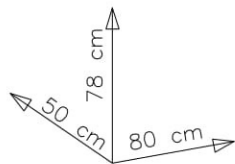
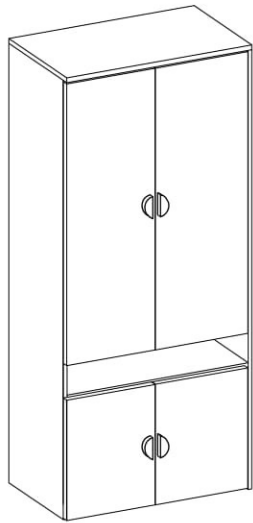
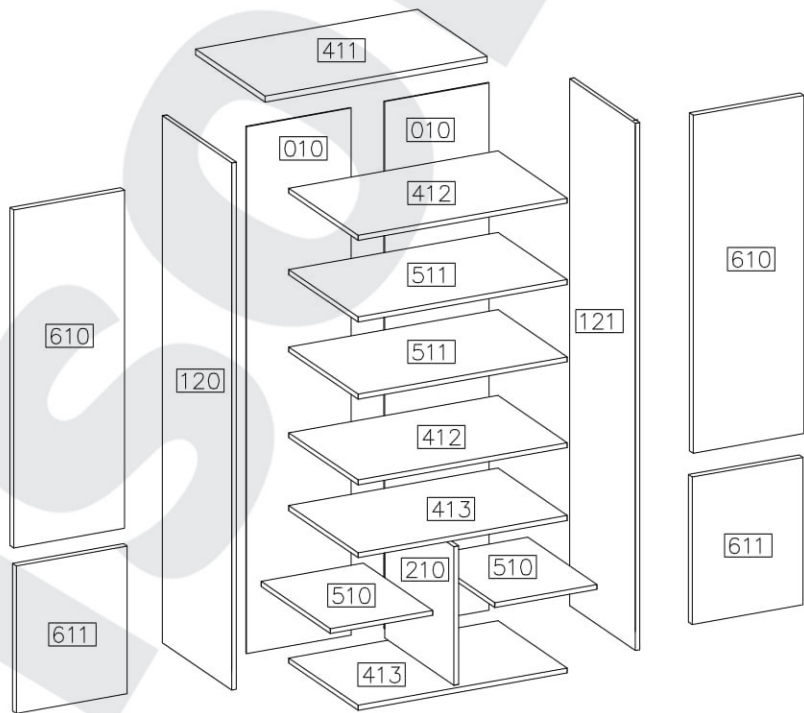

D1	C	E	A	P1	J4	G6	H4	G7
24	24	24	36	20	16	5	10	5
F10	S1	R2	F1	Z1				
60	4	4	6	1				





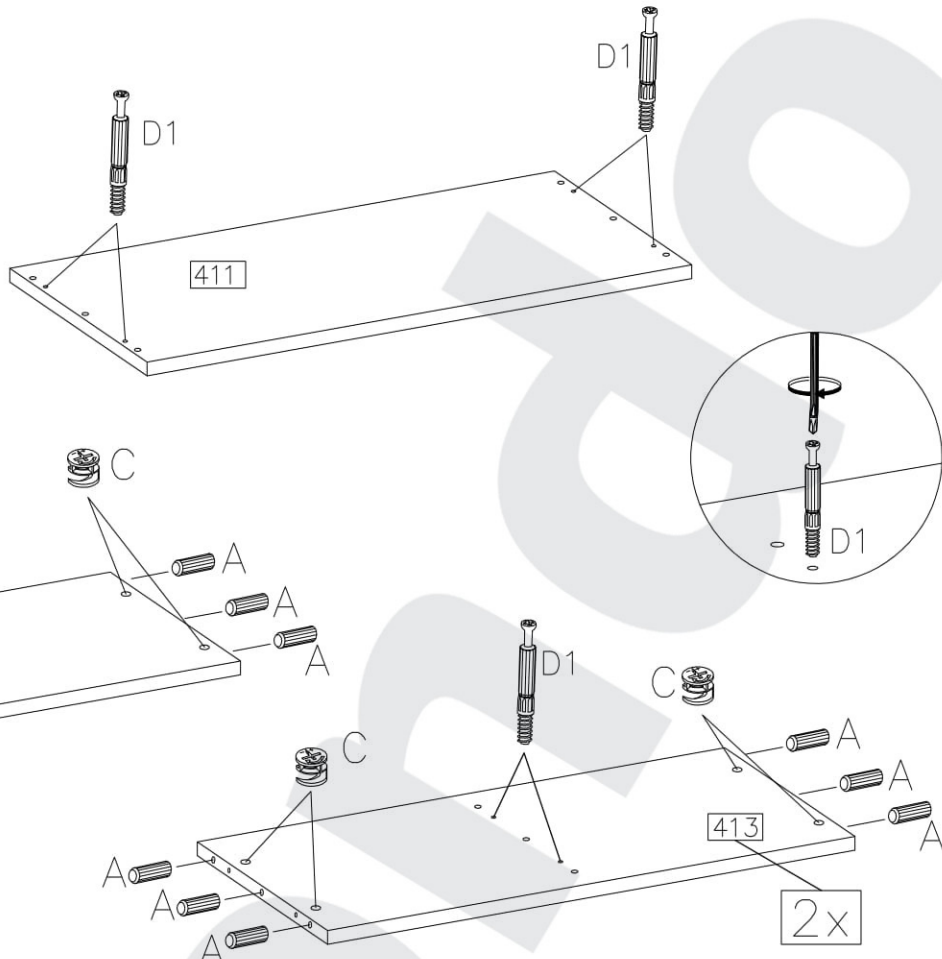

1

	$\varnothing 15/12\text{mm}$	$\varnothing 8 \times 30\text{mm}$
D1	C	A
8	16	24



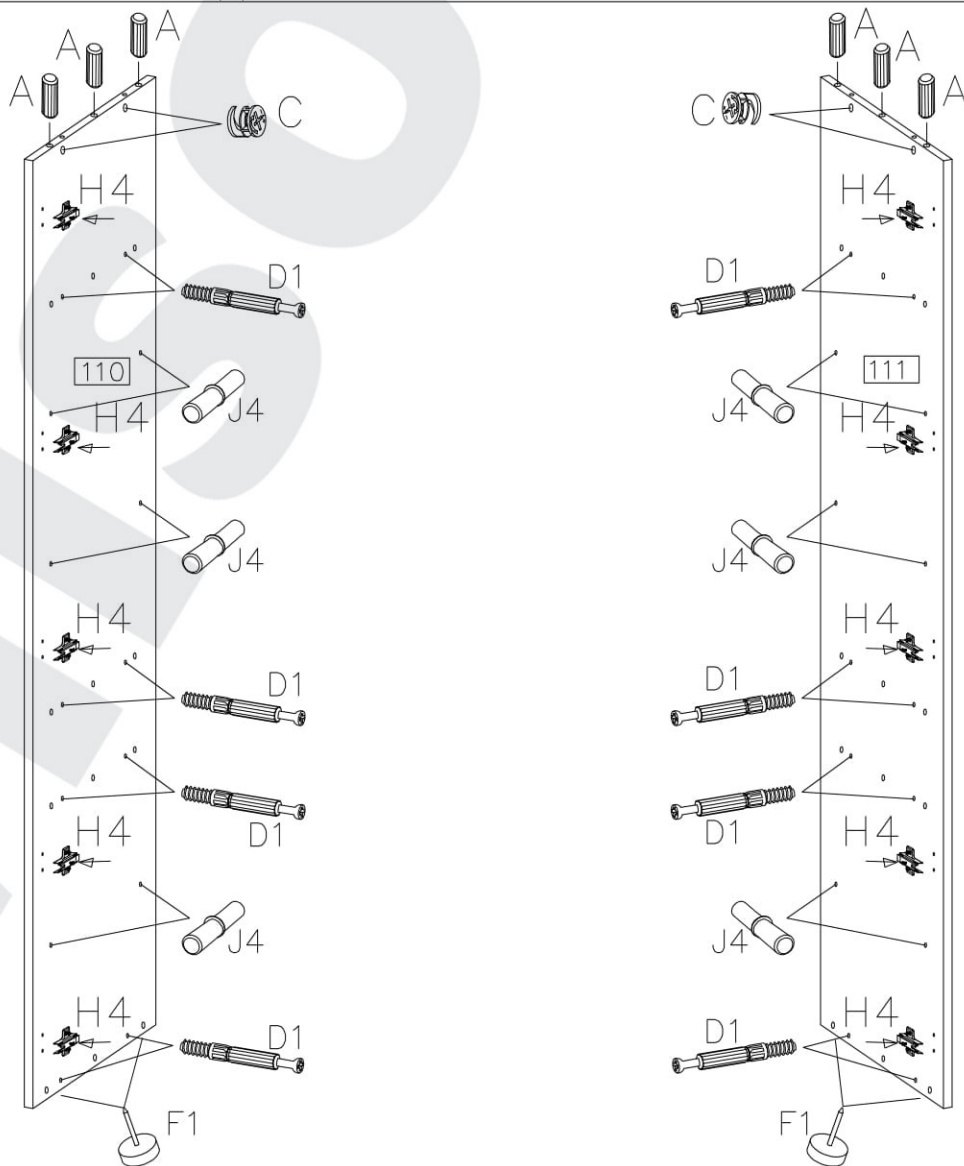
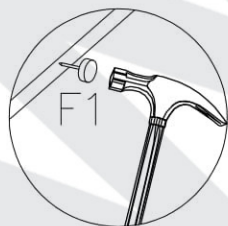
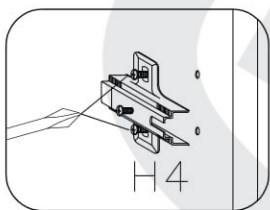

2

	$\varnothing 8 \times 30\text{mm}$
D1	A
16	6
$\varnothing 15/12\text{mm}$	
	
C	J4
4	12
H=0	
	
H4	F1
10	4



3

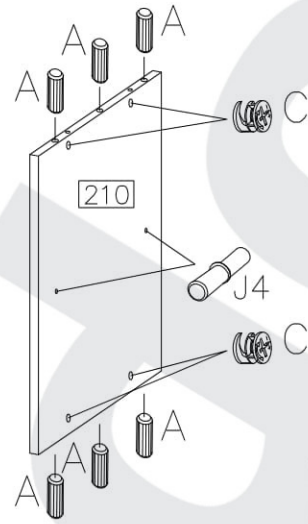
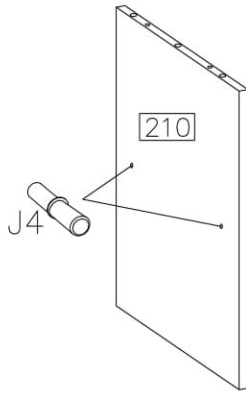

$\varnothing 15/12\text{mm}$  C 4	$\varnothing 8 \times 30\text{mm}$  A 6
 J4 4	

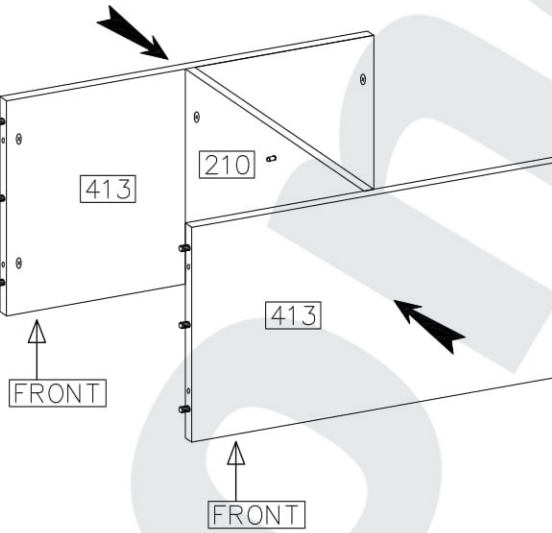
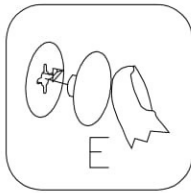
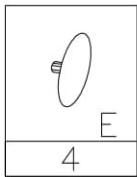

4



5

 E 20
 F1 2

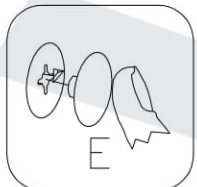
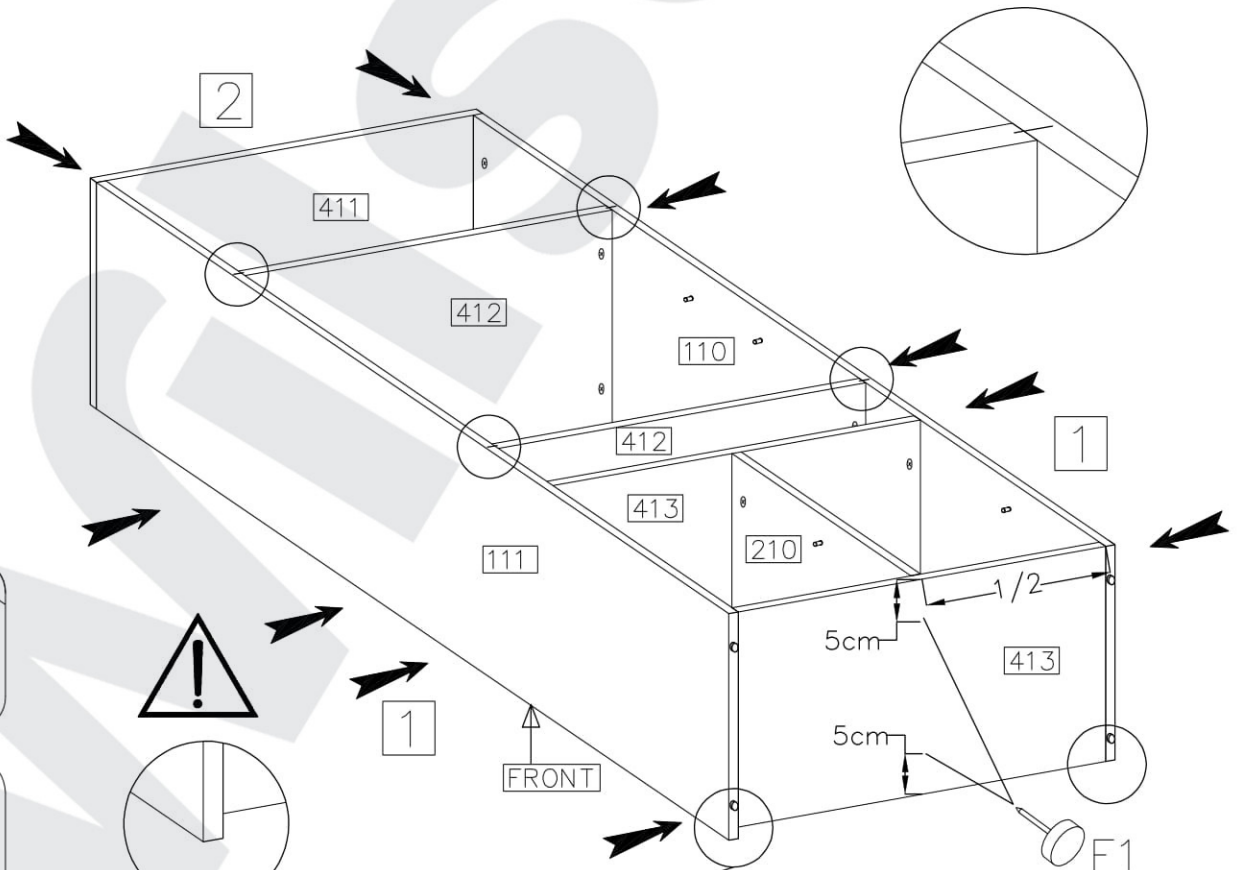

6

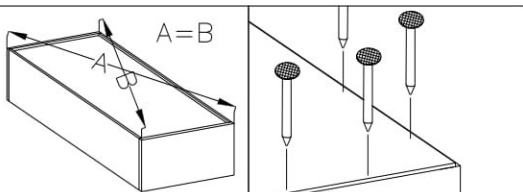
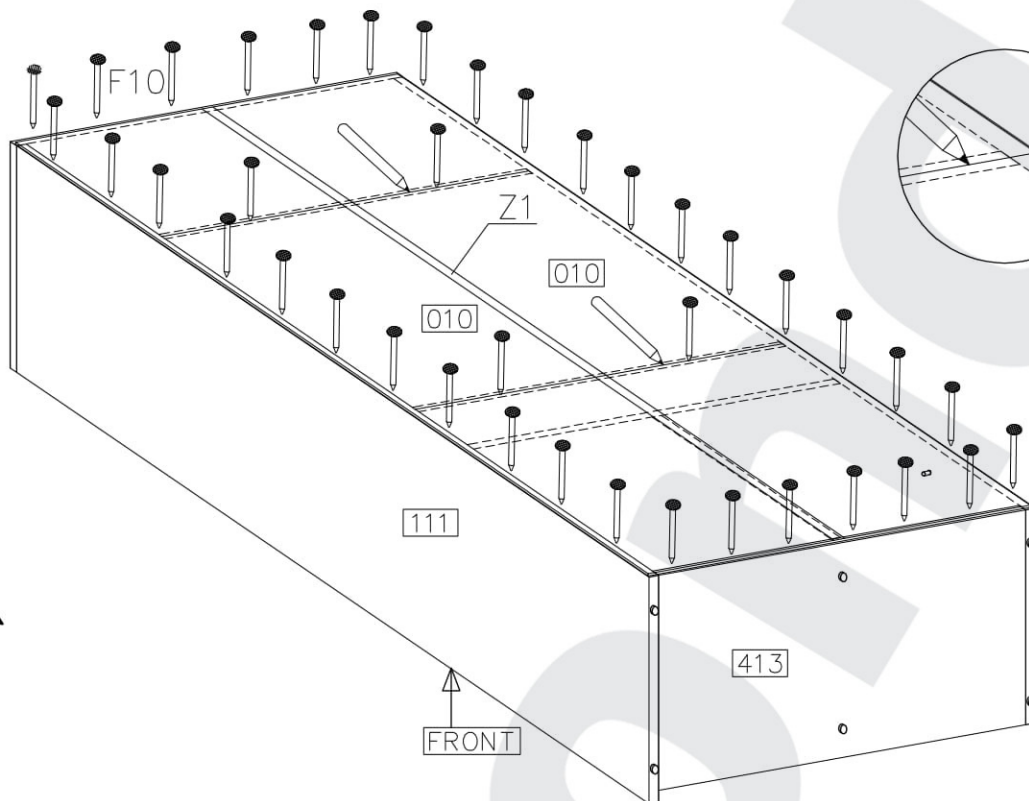
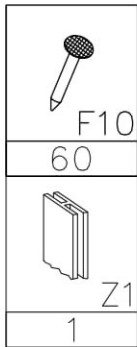
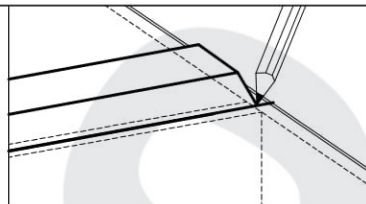
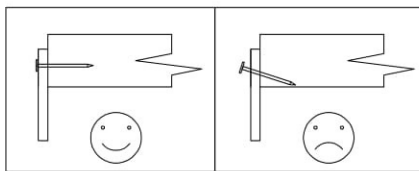

7

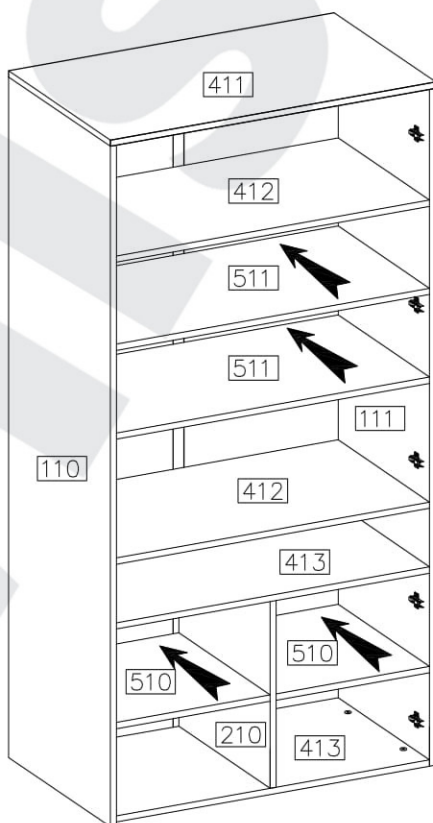

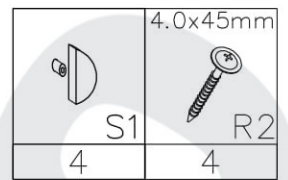
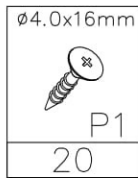
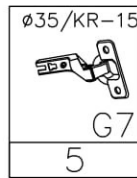
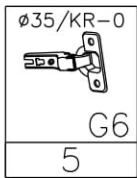

3

