

MILANO S5

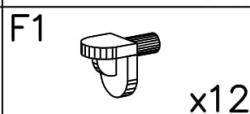

1

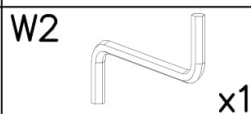
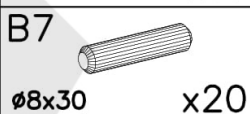
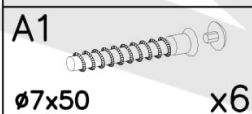
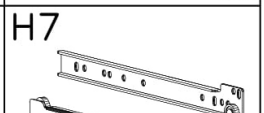
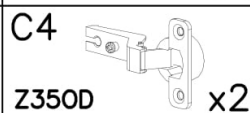
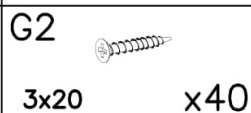
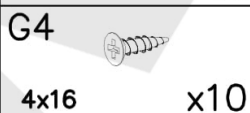
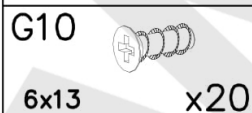
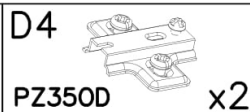
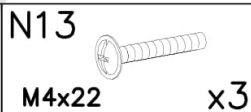
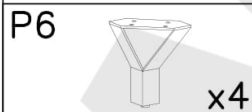
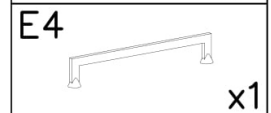
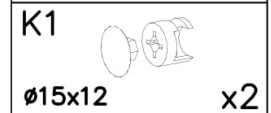
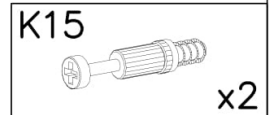
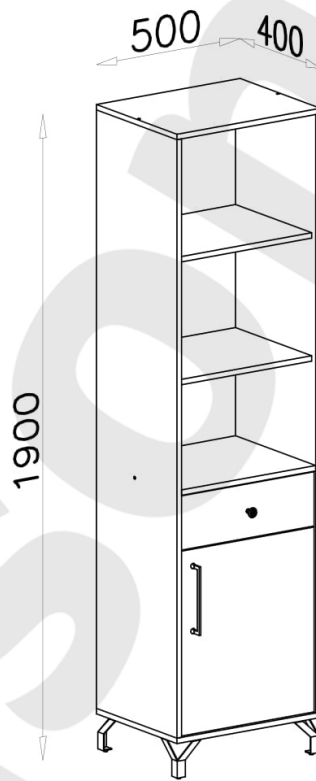
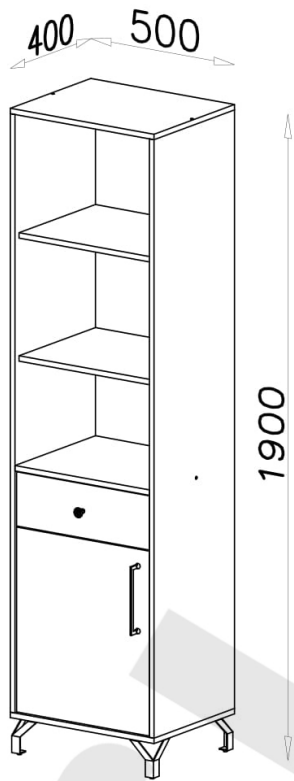
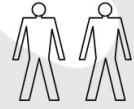
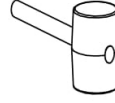
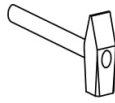
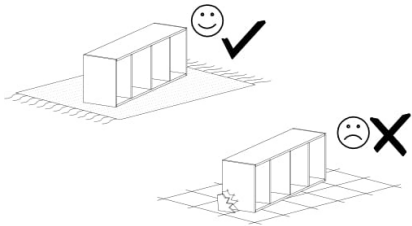
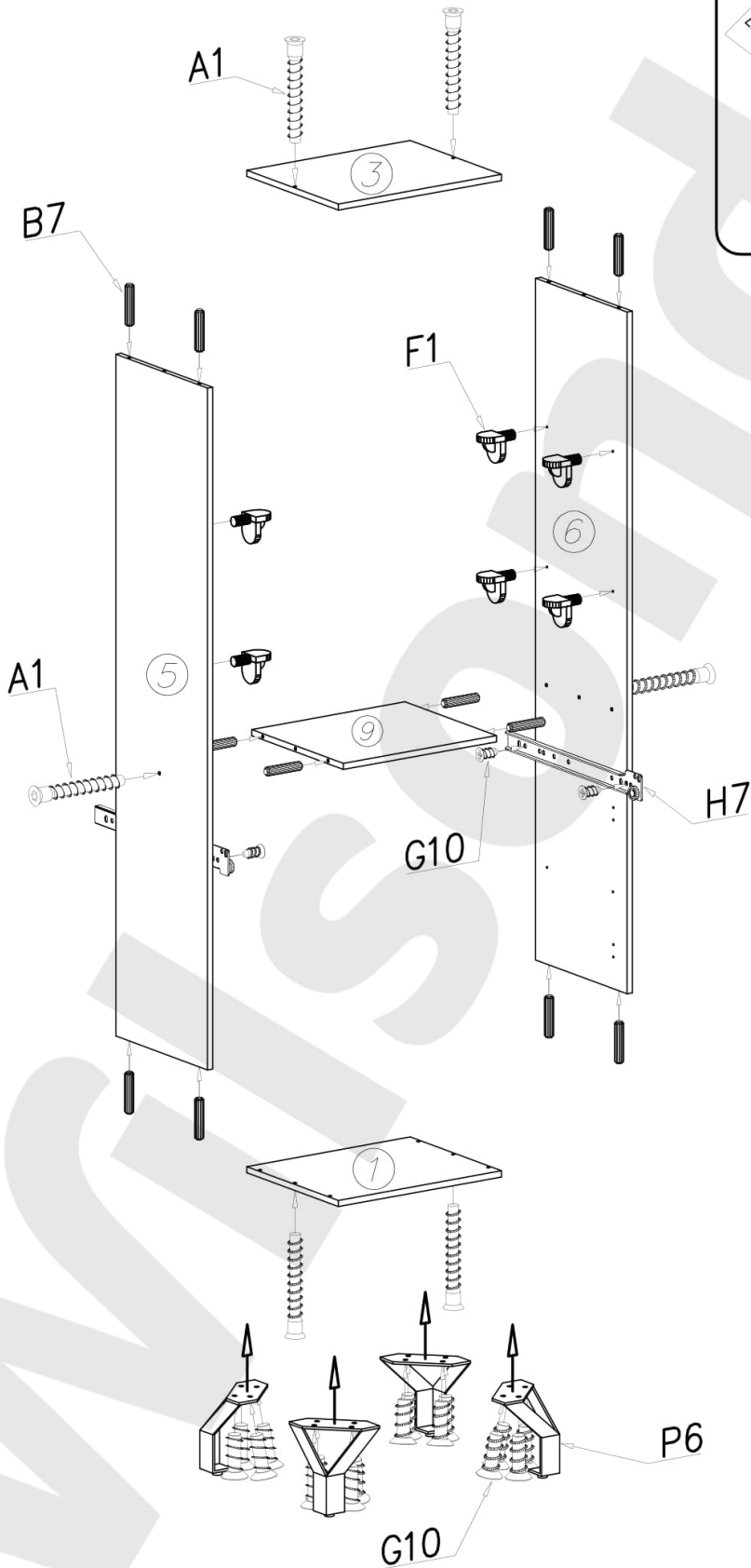

II

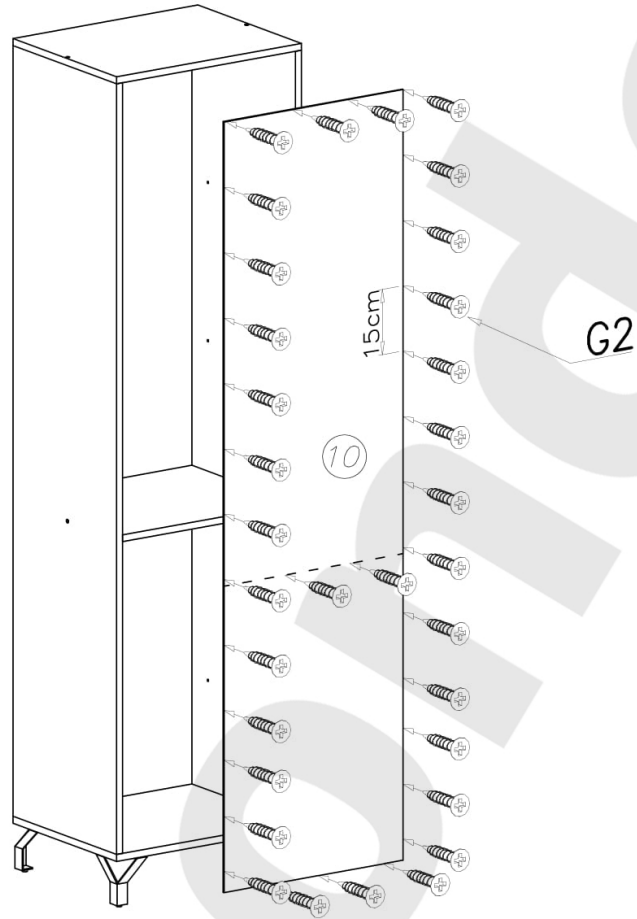

III

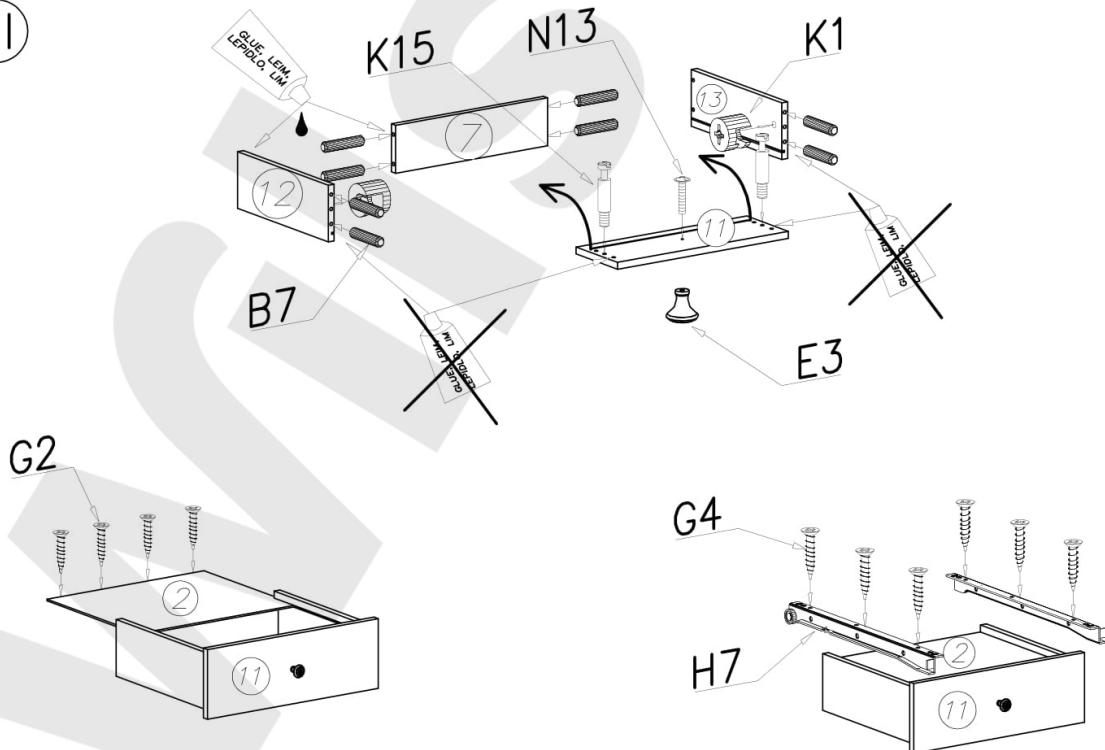

IV

