

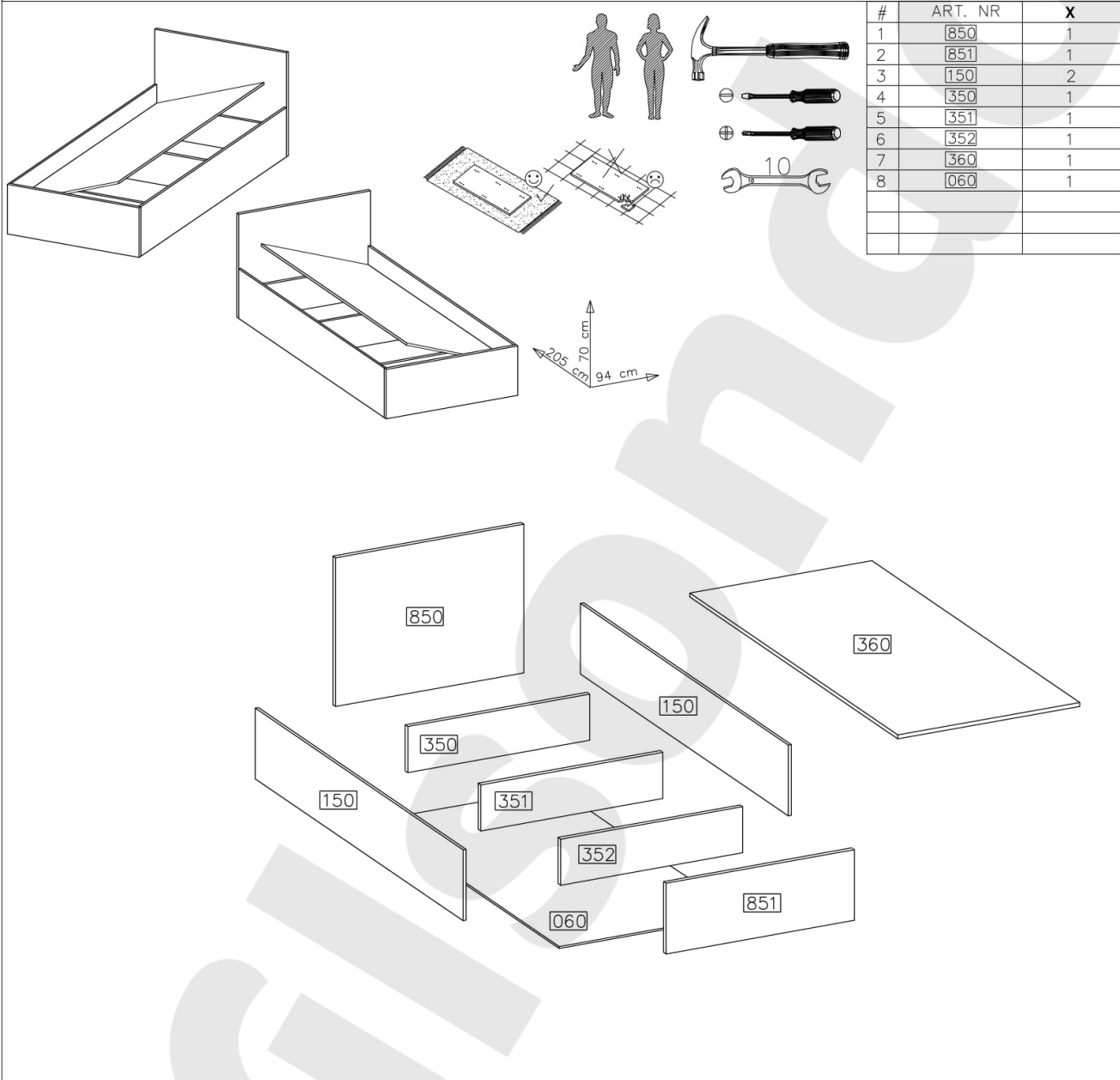











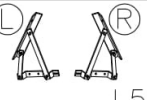

PL - ŁÓŻKO SVEND / SK - POSTEL' SVEND / HU - ÁGY SVEND

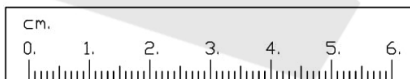

 D1	 C	 E	 A	 F10	 L5
20	20	4	20	50	1KPL
 T2	 S6	 F1	 L6		
1	8	11	2		





1

$\varnothing 8 \times 30 \text{mm}$  A 8	$\varnothing 15 / 12 \text{mm}$  C 8	 D1 12
--	--	---

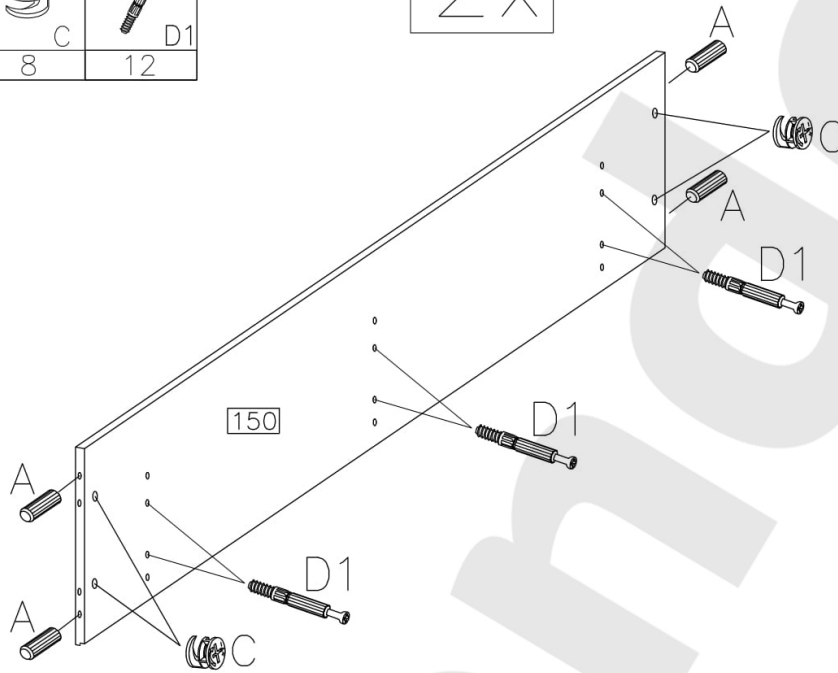
2x



2

$\varnothing 8 \times 30 \text{mm}$  A 12	$\varnothing 15 / 12 \text{mm}$  C 12
---	---

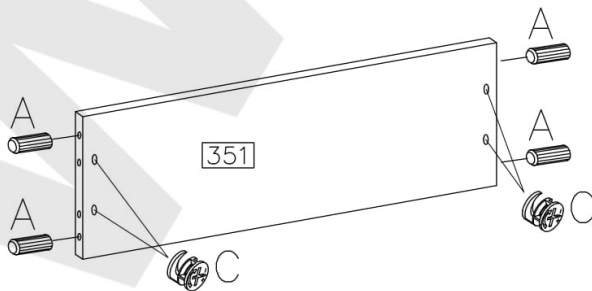
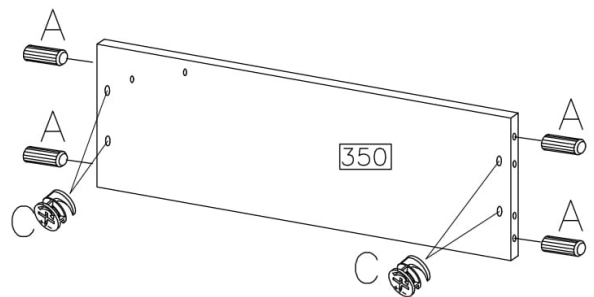
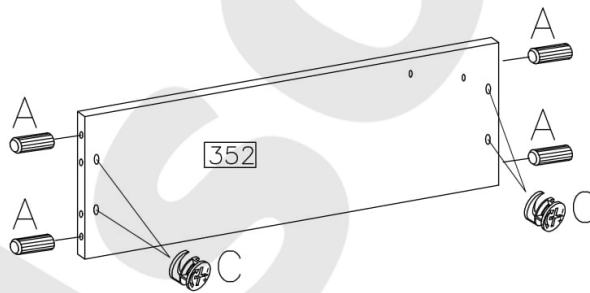

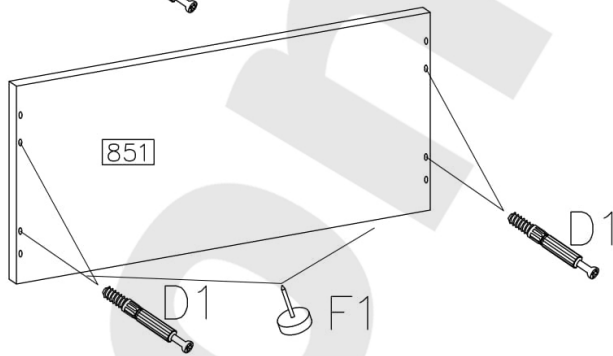
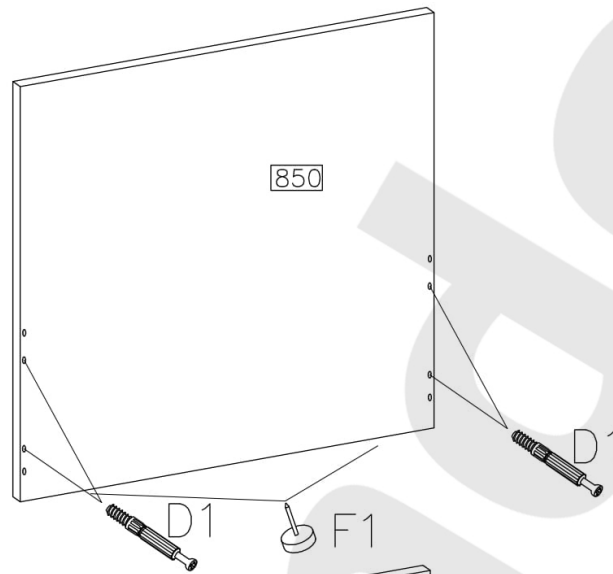
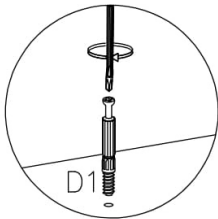
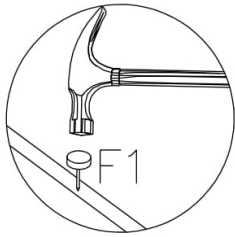
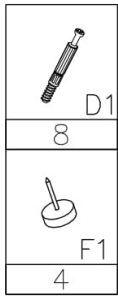

3

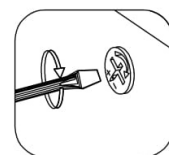
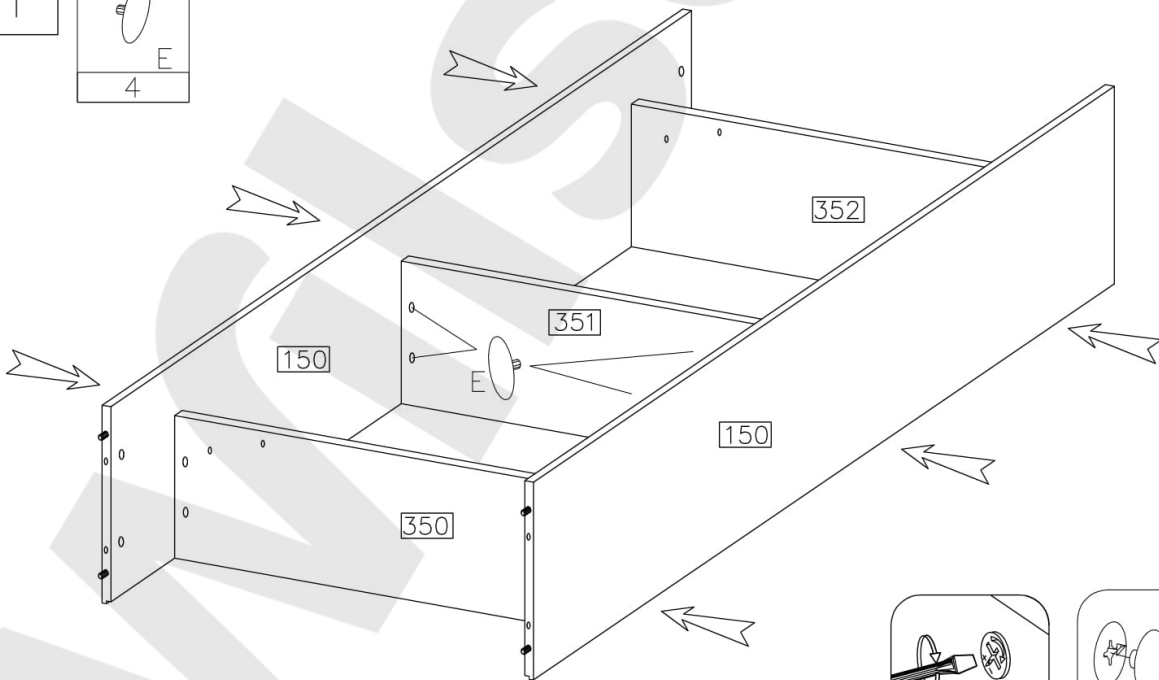
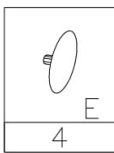

4





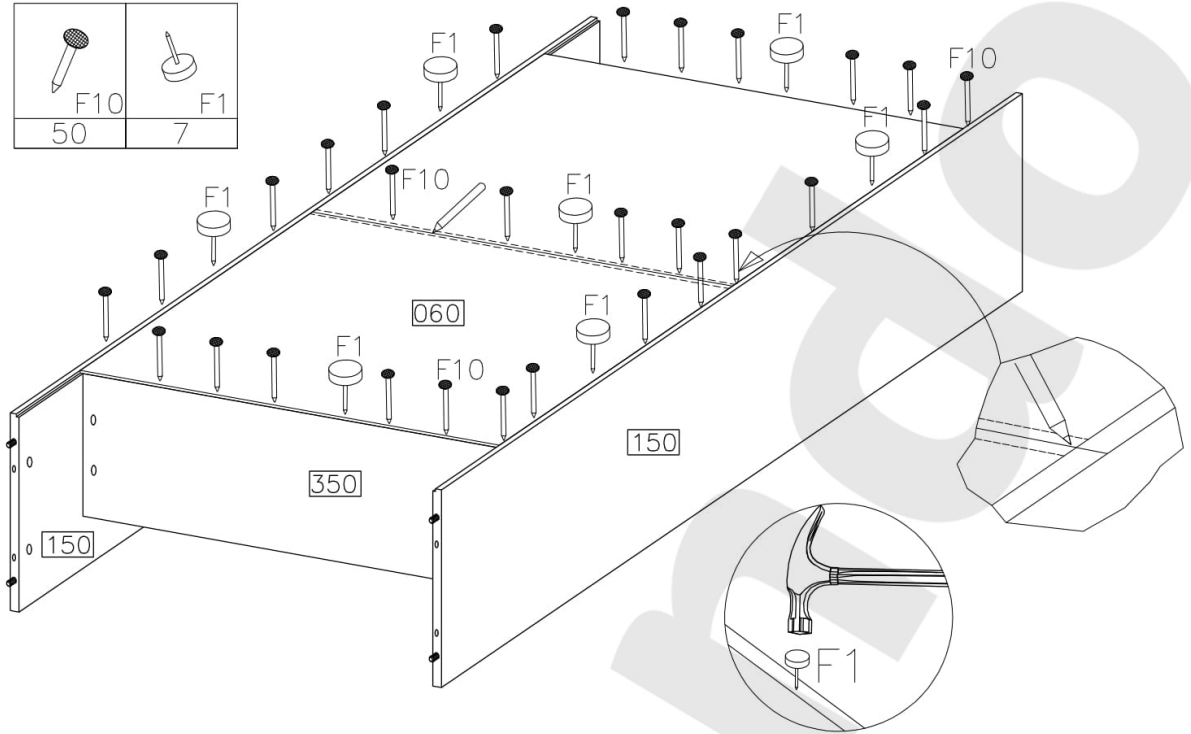

5

	
F10	F1
50	7



6

		M6.0x25mm
L5	L5	
1KPL		S6
		4

L6
2

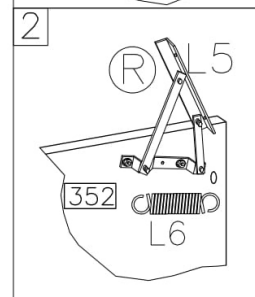
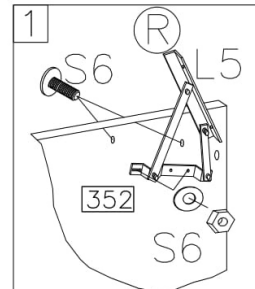
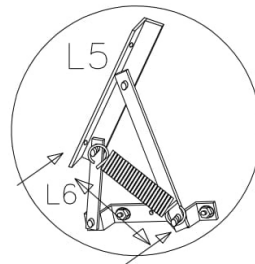
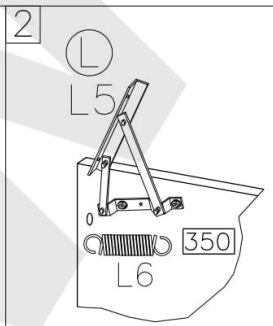
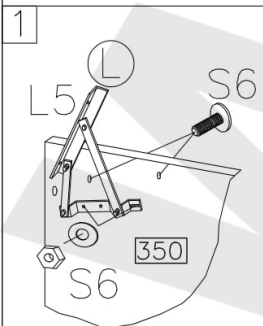
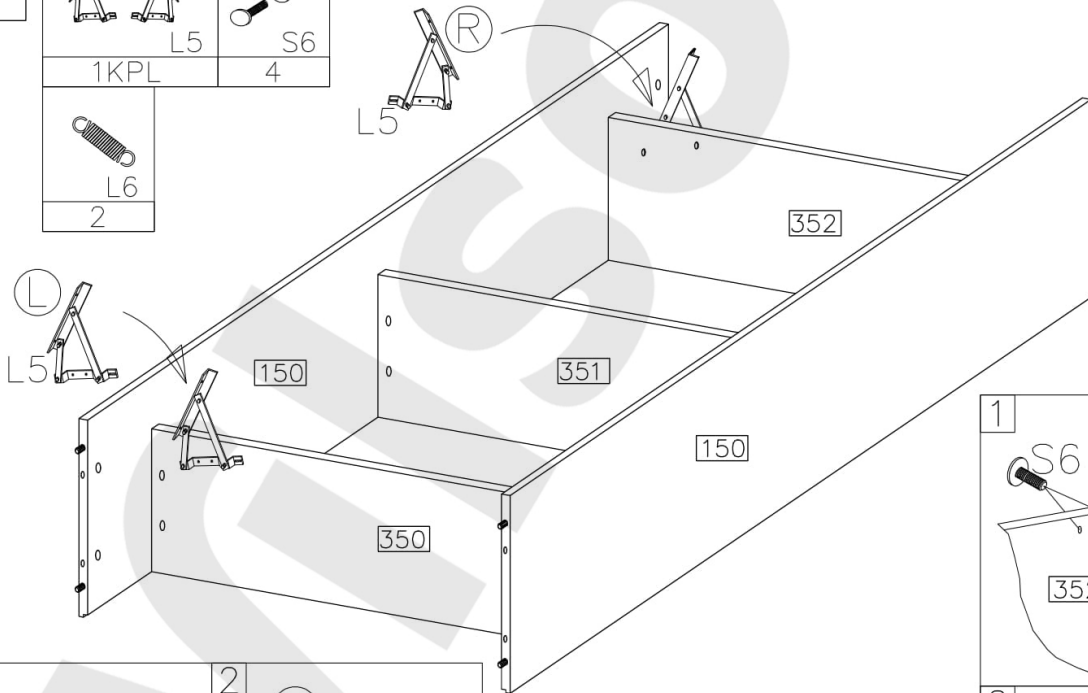

7

	M6.0x25mm
T2	S6
1	4

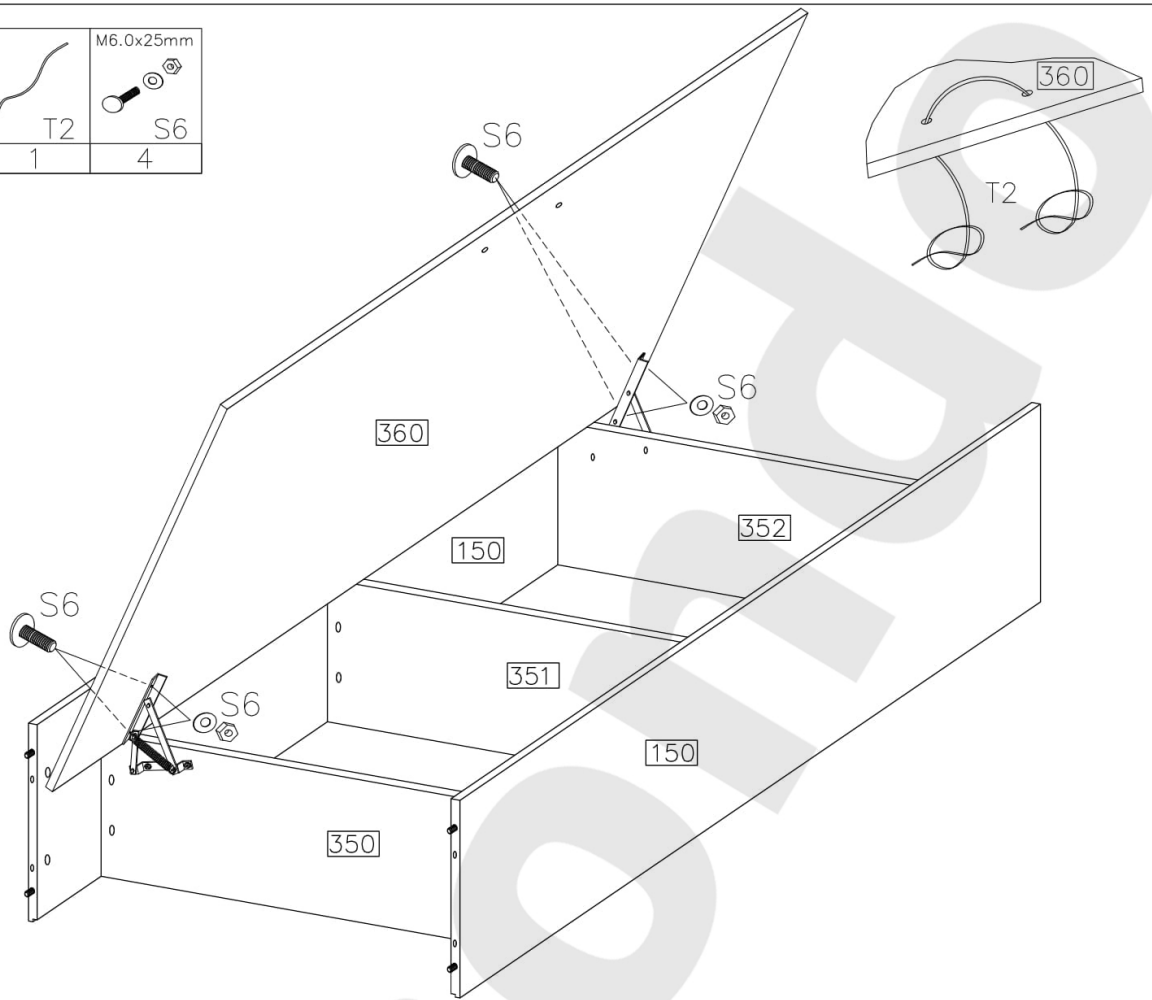

8

