

PL - SZAFKA MONTE / D - GARDEROBESCHRANK MONTE / GB - WARDROBE MONTE / SK - SKRIŇA MONTE / HU - SZEKRÉNY MONTE

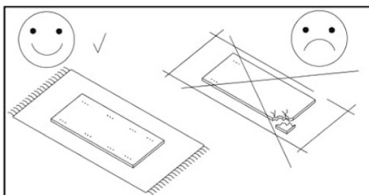

2 hours

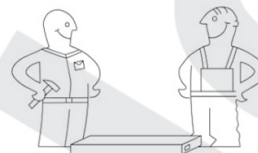
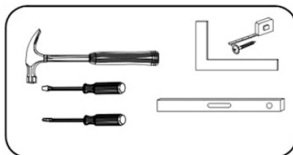
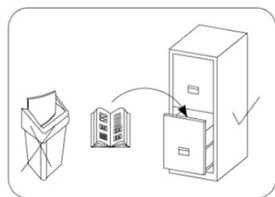
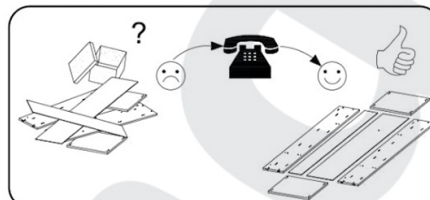

UWAGA / ACHTUNG / CAUTION / POZOR / VIGYÁZAT

PL>Czyszczenie należy wykonać wyłącznie za pomocą ściereczki lub lekko nawilżonego ręcznika.
Nie stosować środków czyszczących do szorowania.

Szanowny kliencie, jeśli podczas montażu stwierdzisz uszkodzenie lub brak części, proszę podaj jej kod alfanumeryczny lub zaznacz ją na instrukcji montażu i prześlij wraz z protokołem reklamacyjnym

D>Bitte nur mit einem Staubtuch oder leicht feuchtem Lappen reinigen. Keine scheuerenden Putzmittel verwenden.

Sehr geehrter Kunde, sollte ein Teil fehlen oder beschädigt sein, kreuzen Sie dies bitte deutlich auf der Montageanleitung an und schicken Sie die Montageanleitung mit ein.

GB>Please only clean with a duster or a damp cloth. Do not use any abrasive cleaners.

Dear customer, should there be any piece missing or damaged, kindly mark this piece clearly on the attached assembly instructions and return them to us.

SK>Nábytok by sa mal čistiť iba prachovkou alebo mierne navlhčenou handričkou.

Nepoužívajte žiadne abrazívne čistiace prostriedky.

Vážení zákazníci, ak počas montáže zistíte, že niektorá časť chýba alebo je poškodená, vyznačte ju na montážnom návode a zdokumentované (odfotené) to zašlite na naše reklamčné oddelenie.

HU>A bútort csak portörlővel, illetve enyhén nedves ronggyal ajánljuk tisztítani. Ne használjon semmilyen agresszív tisztítószer.

Kedves Vásárló, amennyiben az összeszerelés során kiderül, hogy a termék bármelyik része hiányzik vagy sérült, kérem jelölje be azt a szerelési útmutatón, majd dokumentálja (fényképezze le) a hibás részt, így küldje be a reklamációt a részünkre.

8.0x35 D	 M3	 A	 B	3.5x16 H	 I	M4.0x12 V2	 S	 L	"0" Z	 V	 N2
49	4	34	34	28	8	32	12	6	6	8	2
 X	 X	 V1	L-450 mm R		3.0x20 H3	 S1	4.0x35 J	 K	 O	L-509 T1	
32	3	16	1	5	8	2	1	2	1	7	

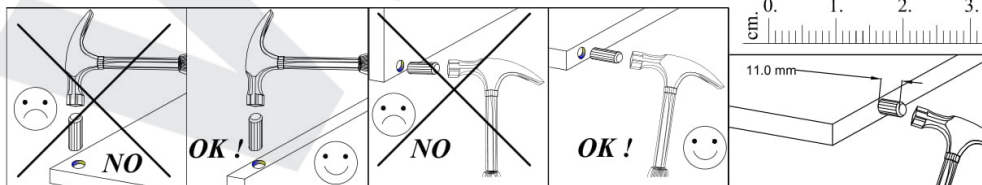

No.	Pcs.	L	W	D	Pac
1	1	900	520	22	1/1
2	1	900	520	22	1/1
3	1	1805	500	16	1/1
4	1	1805	500	16	1/1
5	1	1805	464	16	1/1
6	1	515	464	16	1/1
7	1	515	463	16	1/1
8	3	463	337	16	1/1
9	1	463	337	16	1/1
10	1	1805	60	16	1/1
11	1	493	60	3	1/1
12	1	1799	345	16	1/1
13	1	1556	521	16	1/1
14	1	521	213	16	1/1
15	1	1819	530	3	1/1
16	1	1819	352	3	1/1
17	1	460	154	16	1/1
18	1	460	154	16	1/1
19	1	436	136	16	1/1
20	1	467	451	3	1/1
21	1	867	100	16	1/1
22	1	464	60	22	1/1

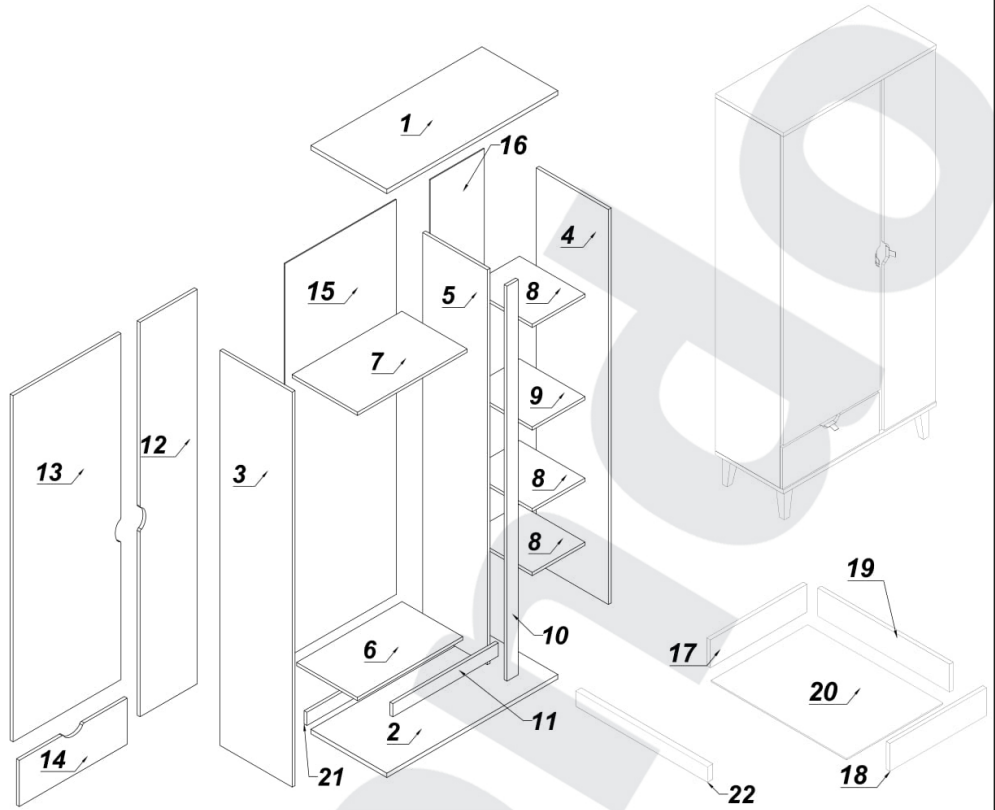

1

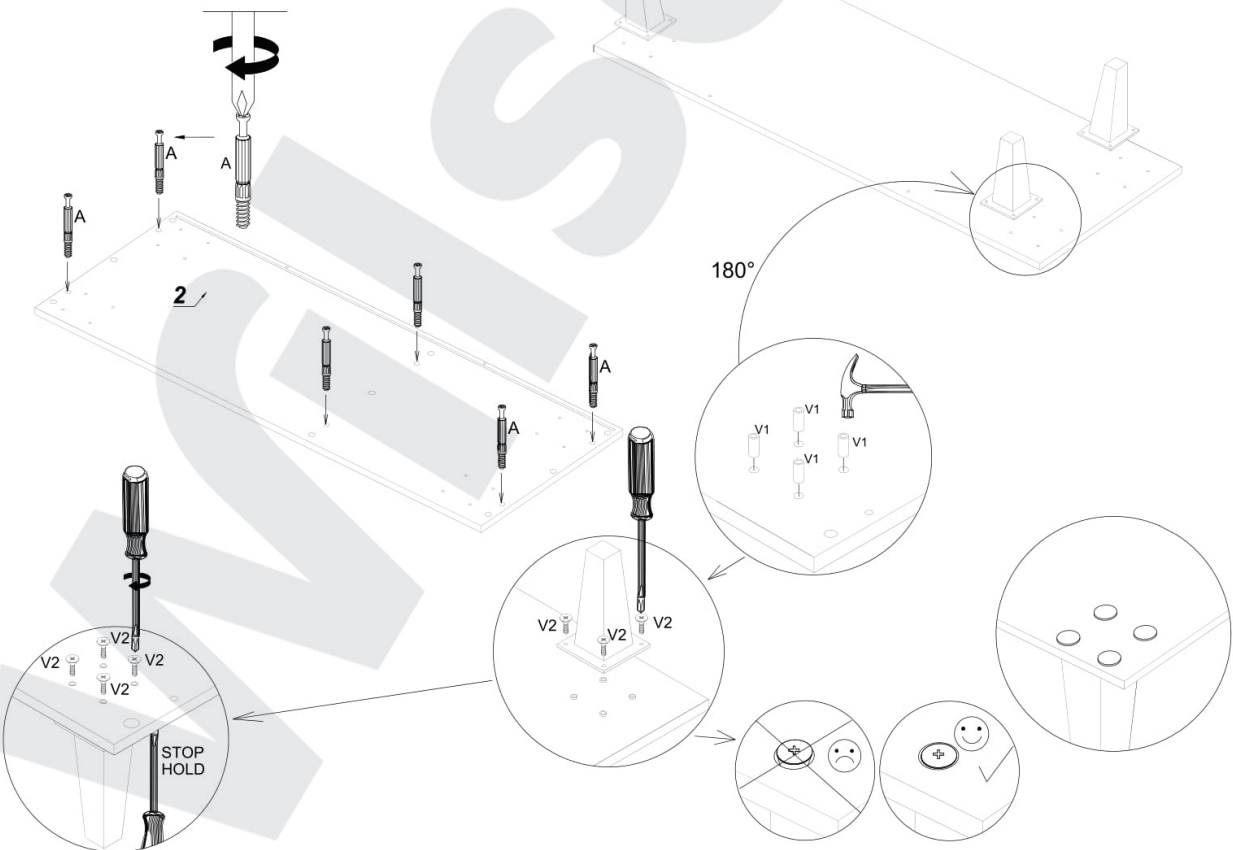
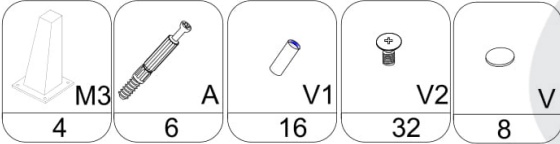

2

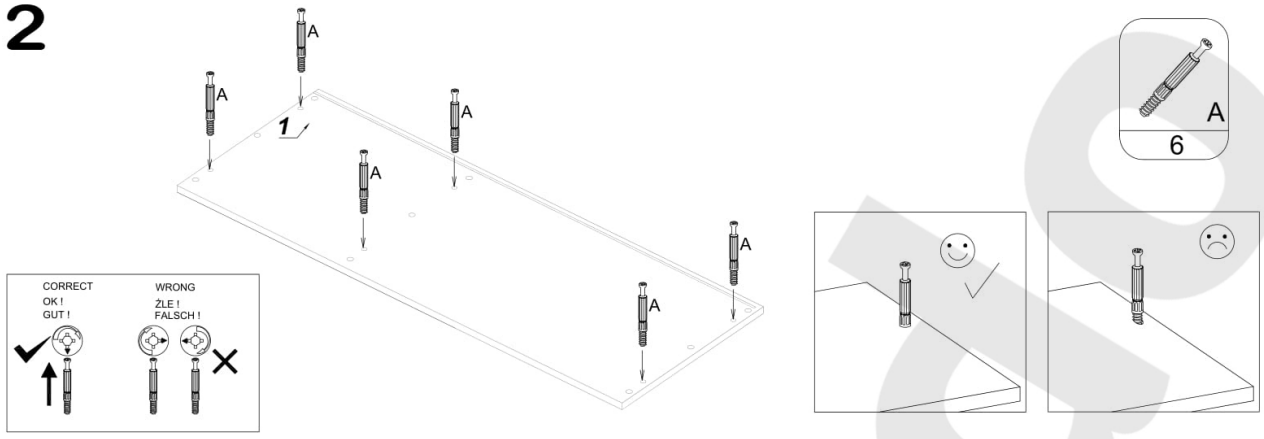

3

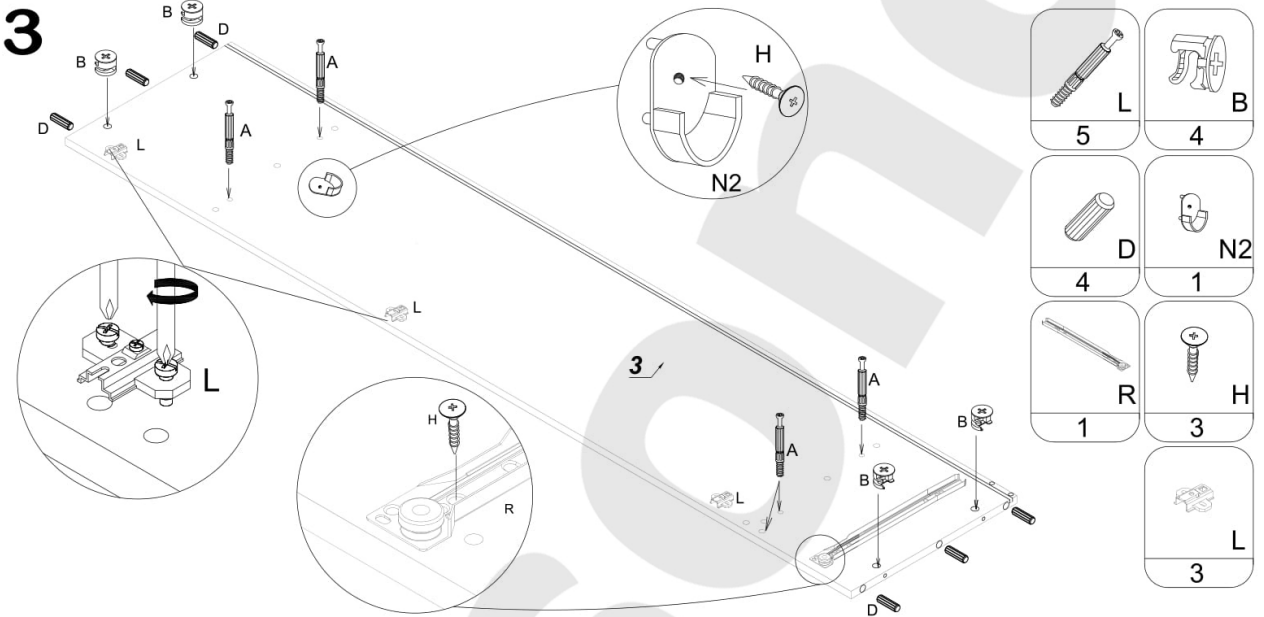

4

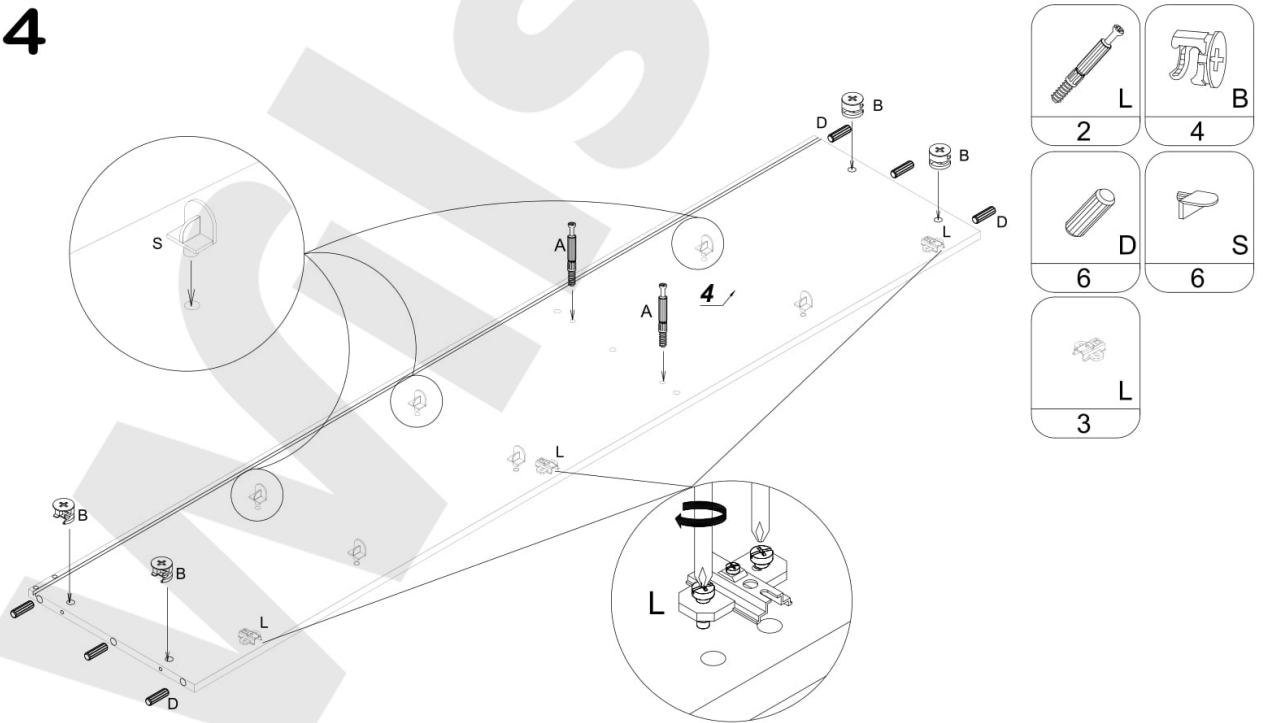

5

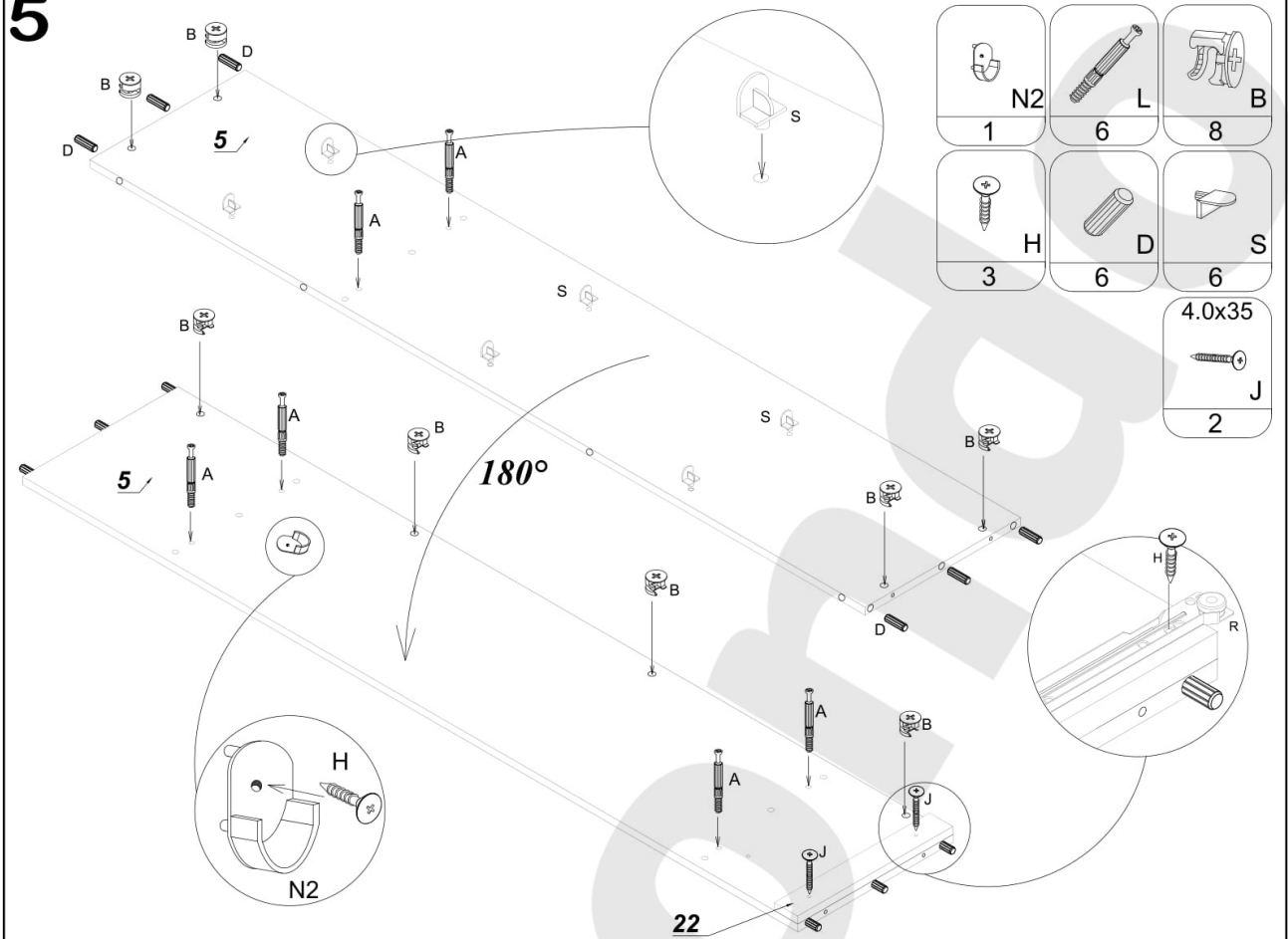

 N2 1	 L 6	 B 8
 H 3	 D 6	 S 6
4.0x35 J 2		

6

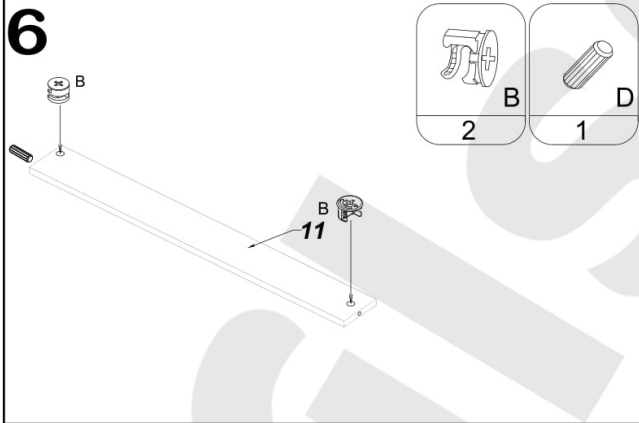

 B 2	 D 1
------------	------------

7

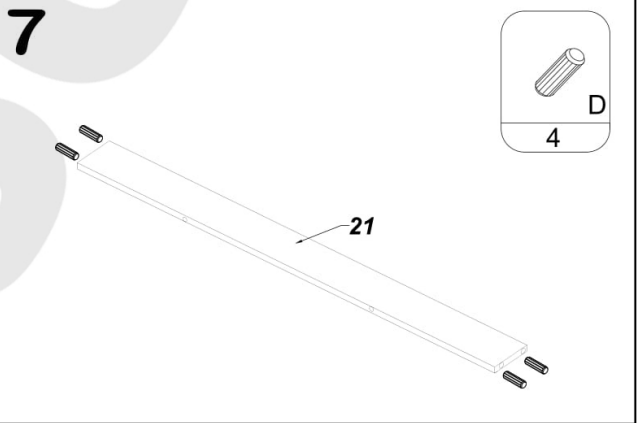

 D 4

8

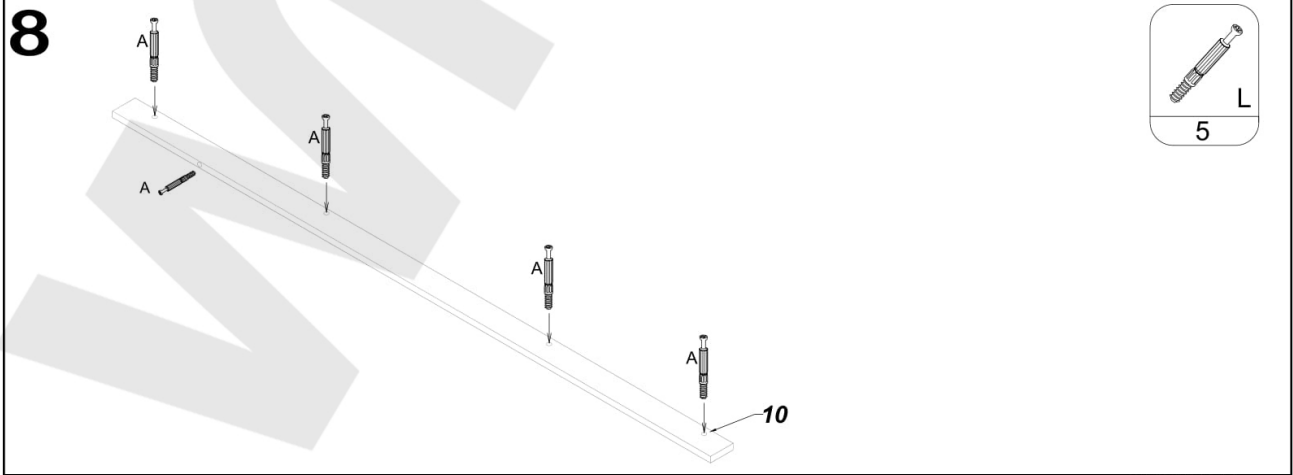

 L 5

9

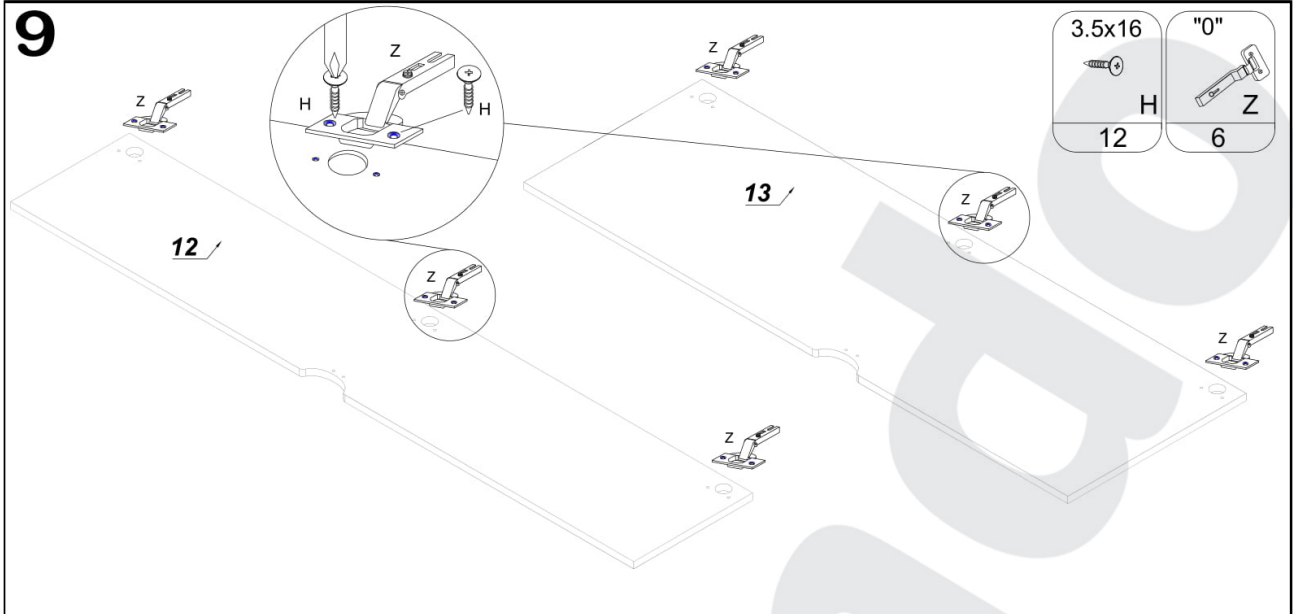

10

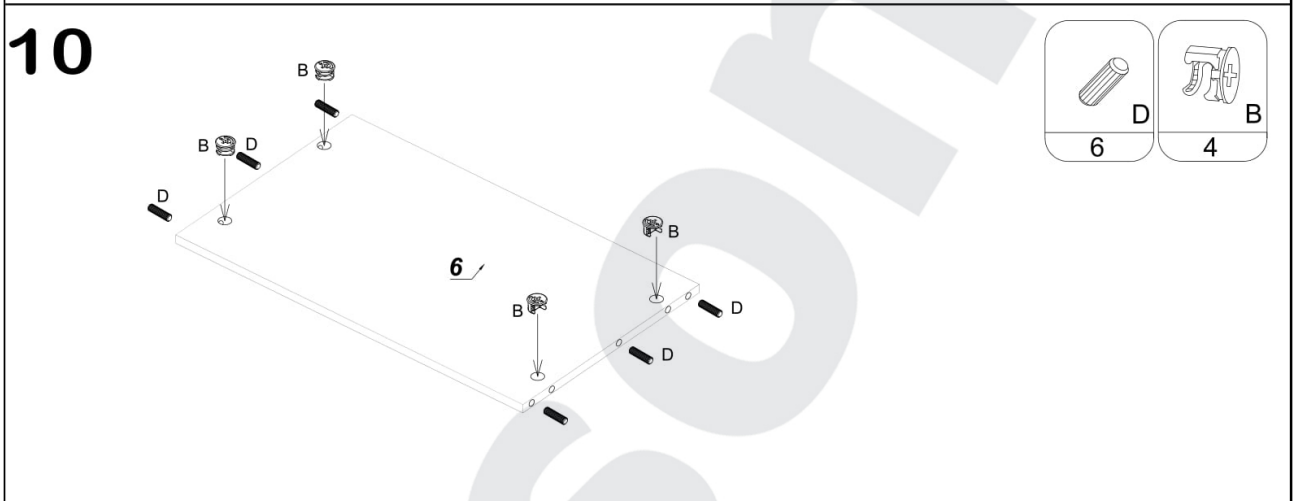

11

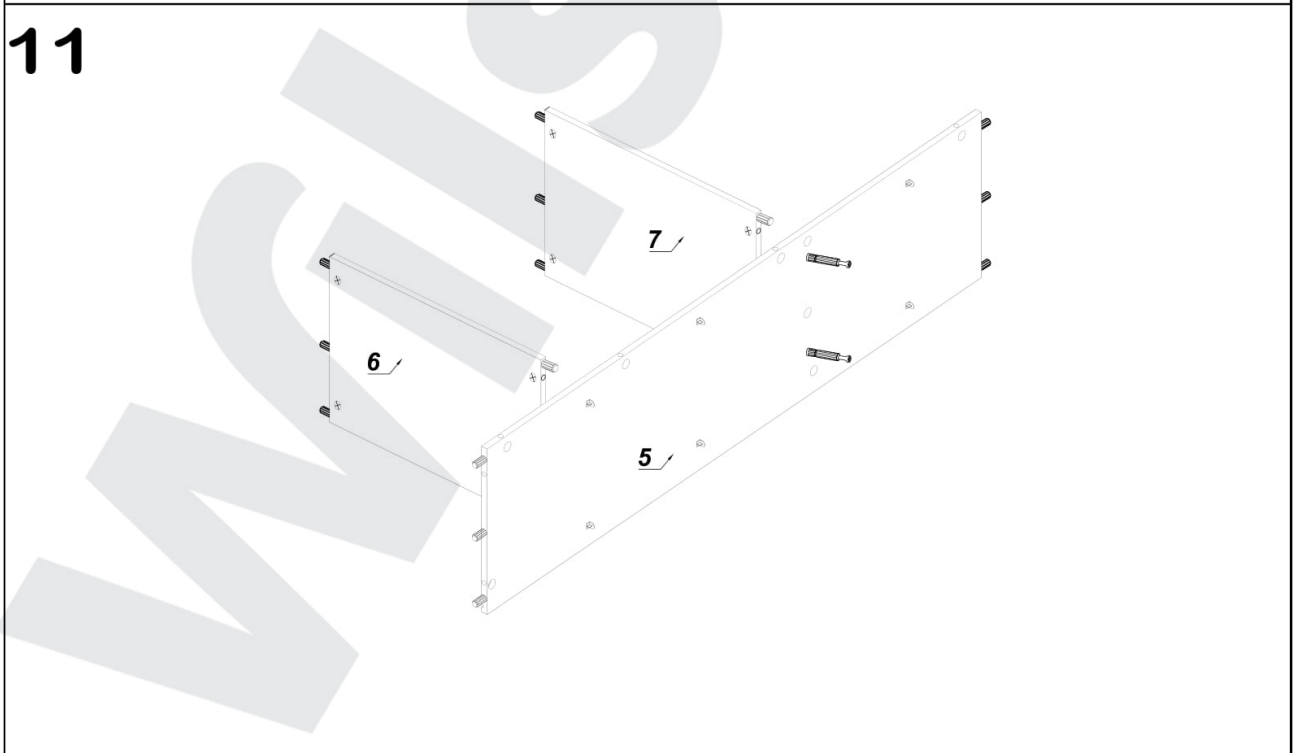

12

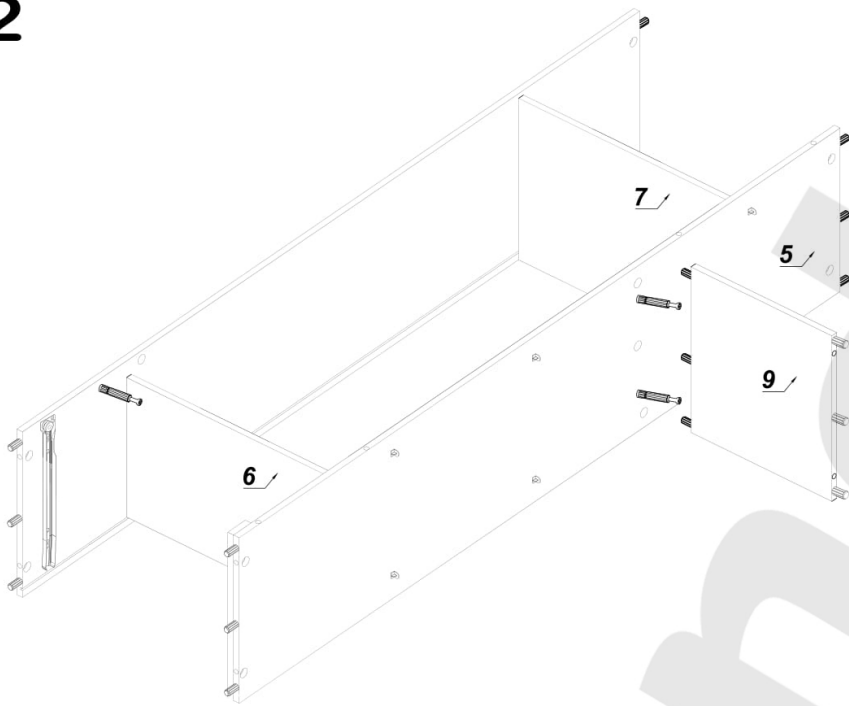

13

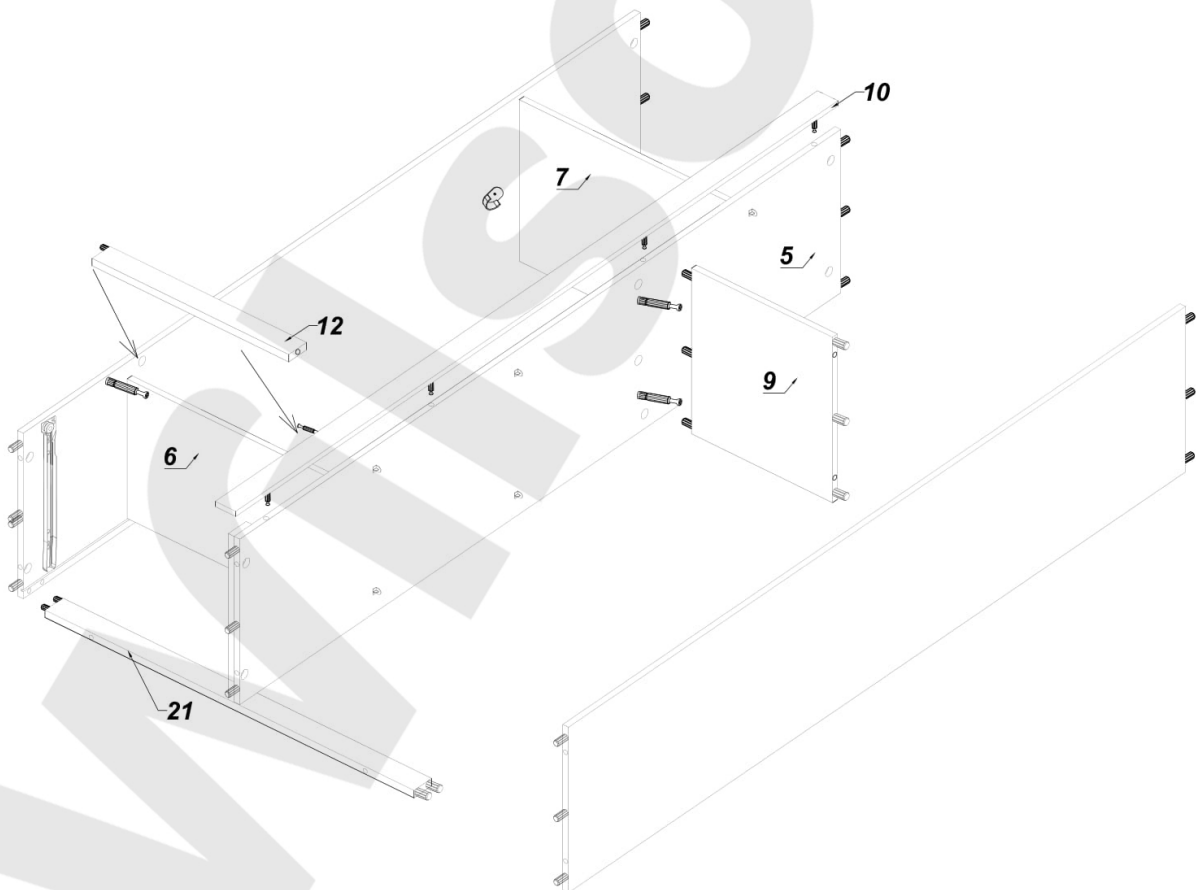

14

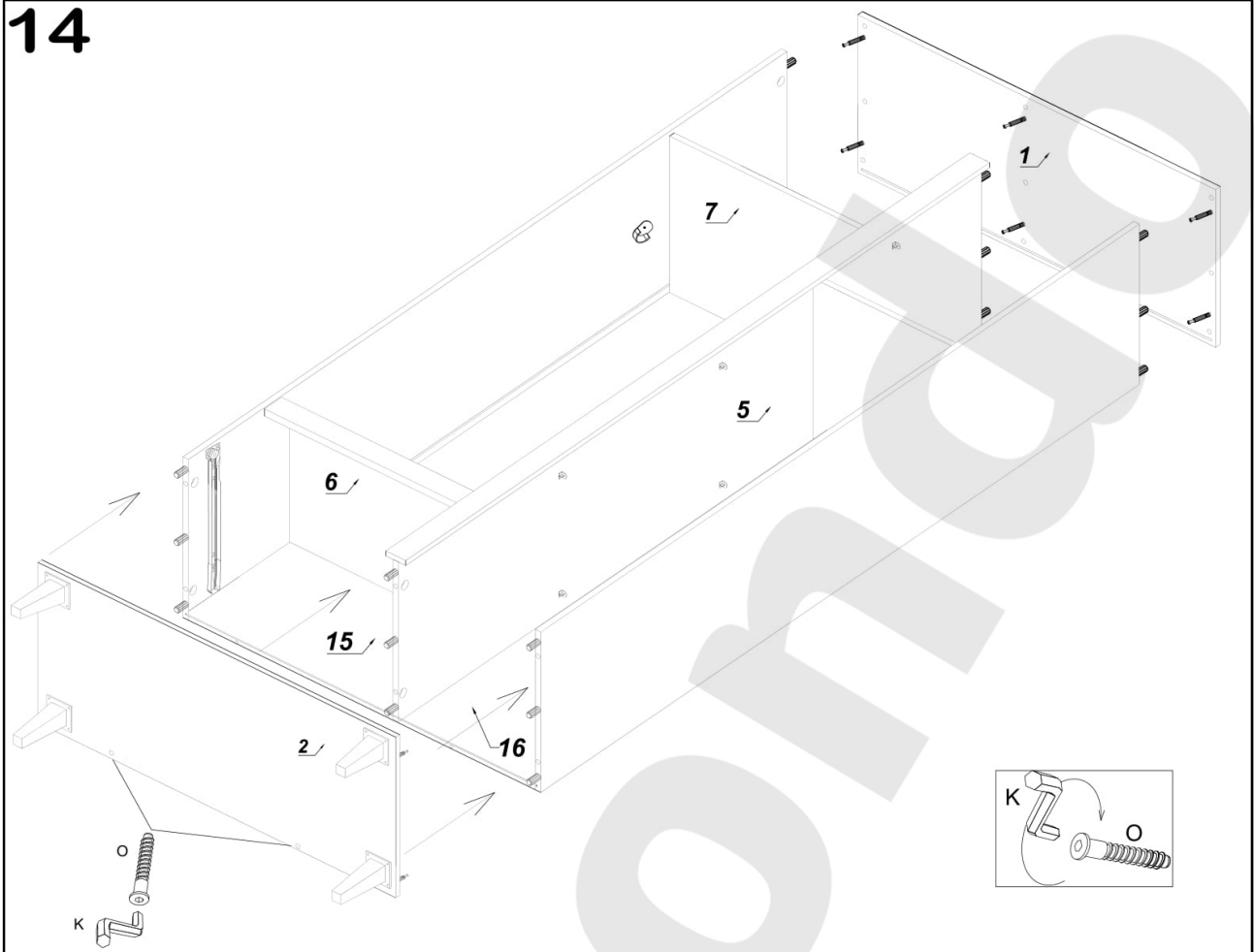

15

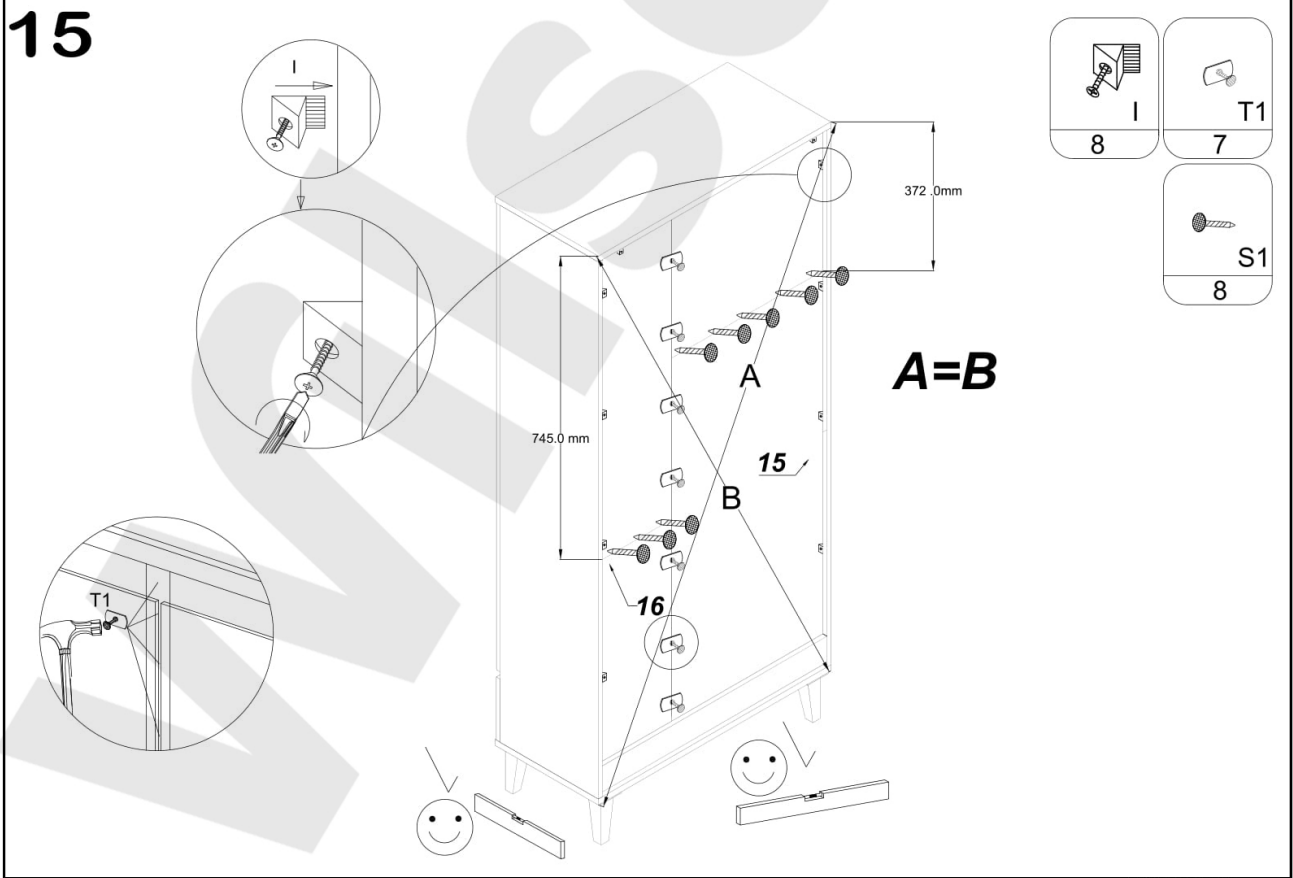

16

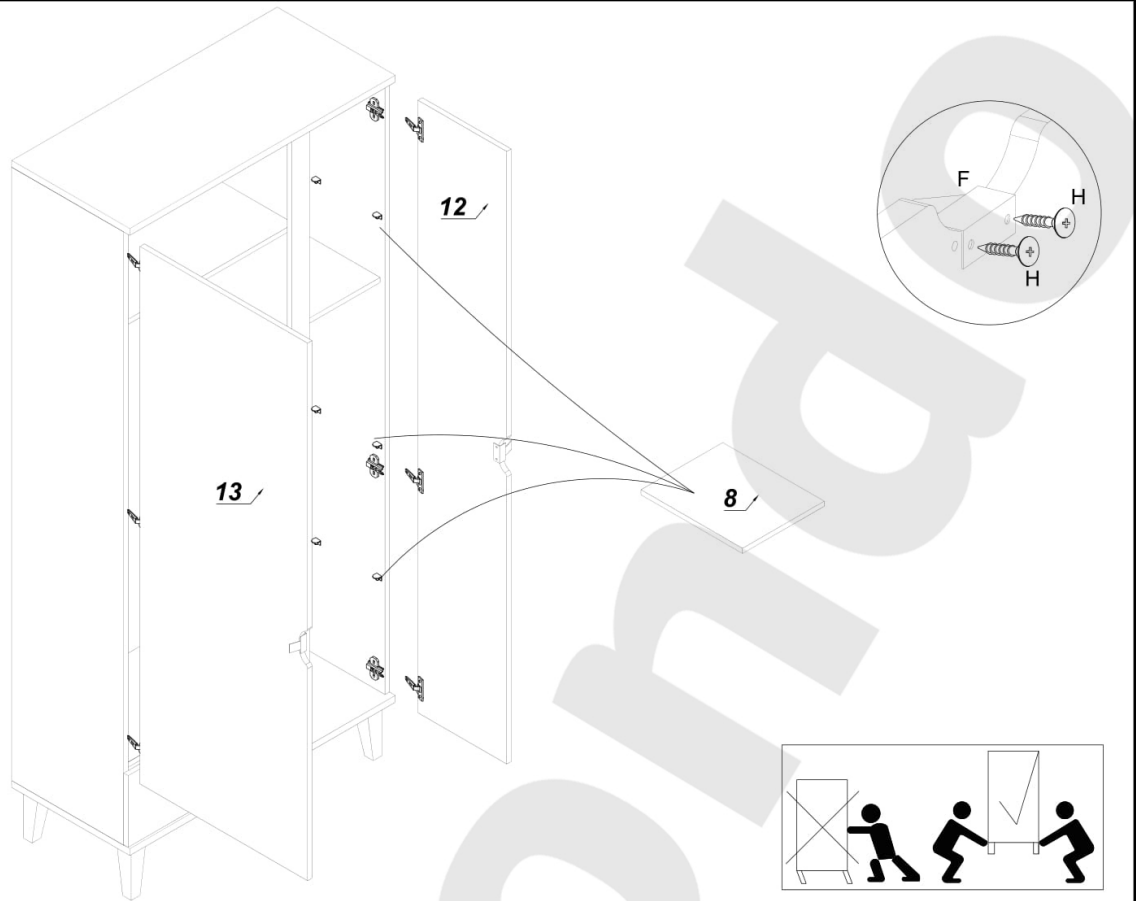

17

